

ROMA SZAFKA 2D2S

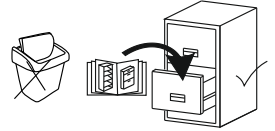

„MEBLE-OKMED” DEMKO - SPÓŁKA JAWNA
 ul. Kolejowa 13, 14-500 Braniewo, POLSKA
www.meblokmed.pl (+48) 55 243 27 26
firma@meblokmed.pl

SERIA: .../...



ROMA SZAFKA 2D2S

SERIA:/..

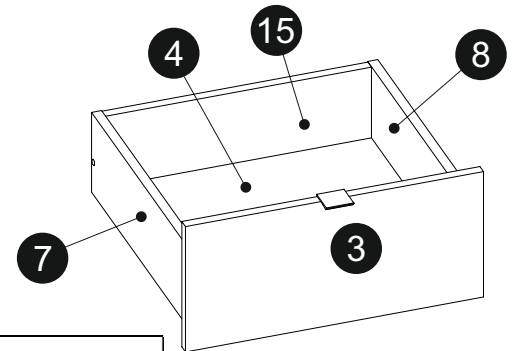
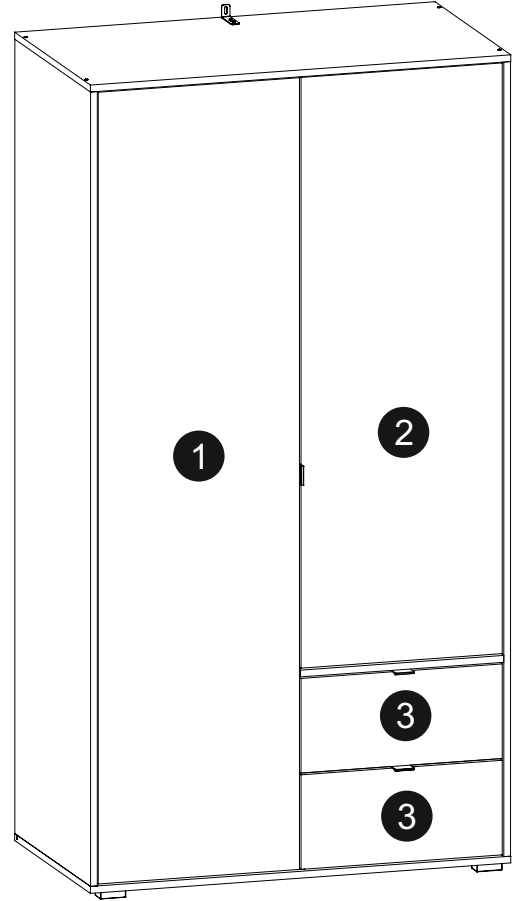
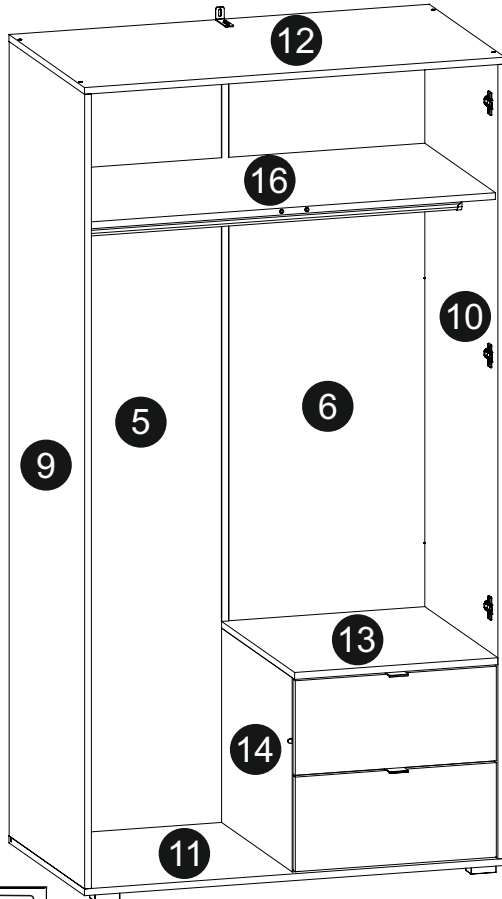

1/3

	L mm	W mm	T mm	
7	450	140	16	x2
8	450	140	16	x2
11	1001	560	16	x1
12	1001	560	16	x1
13	542	484	16	x1
14	452	524	16	x1
15	428	124	16	x2
16	968	524	16	x1

2/3







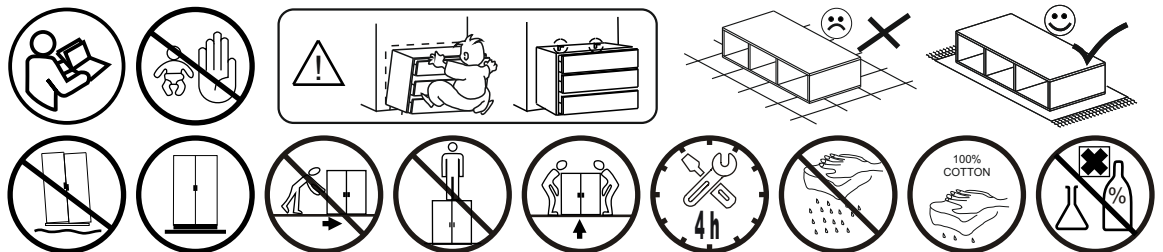
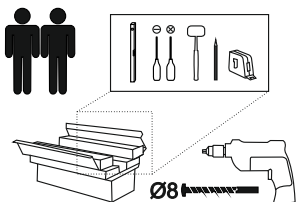

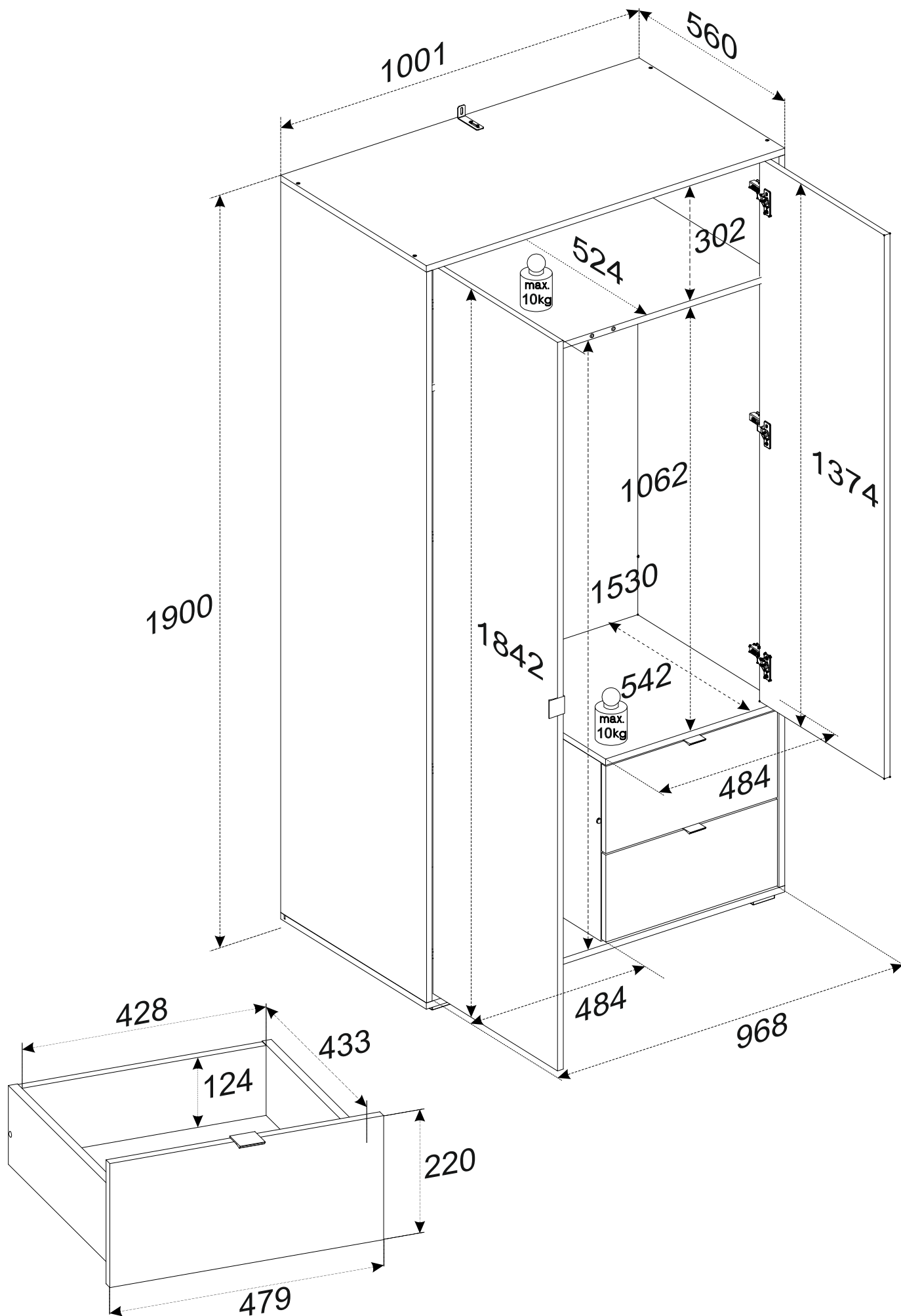



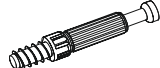

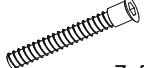
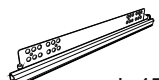
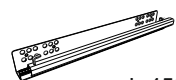



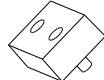

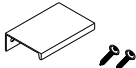
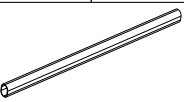
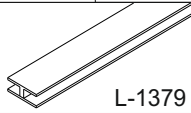
	L mm	W mm	T mm	
9	1848	560	16	x1
10	1848	560	16	x1
4	442	455	3	x2
5	1870	500	3	x1
6	1870	485	3	x1

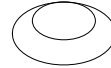
3/3

	L mm	W mm	T mm	
1	1842	479	16	x1
2	1374	479	16	x1
3	220	479	16	x2



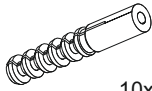
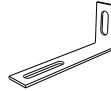
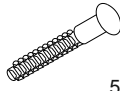
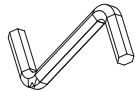



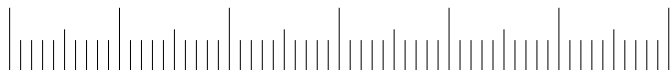

 8x35	 15x15			 7x50	 L-450	 L-450
KT1 39	ZM1A 12	ZM1B 12	ZM1 12	K1 10	PQFL 2	PQFR 2
						
ZWP 7	ZPH2 7	UD1 2	S1 8	SS6 5	PP 1	U71 3
	 L-1379			 3x16	 3,5x16	 4x13
DR963 1	LI 1	PL1 4	OS1 2	W1 16	W11 4	W4 14
 6,3X13	 6x50	 10x50		 5x42		
ME3 8	KRL1 1	KRW1 1	KS1 1	KM1 4	KK1 1	ZK 6

0 mm 10 20 30 40 50 60







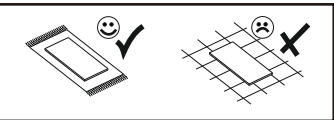
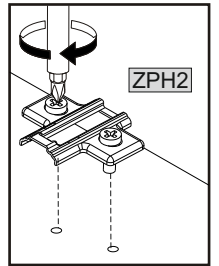
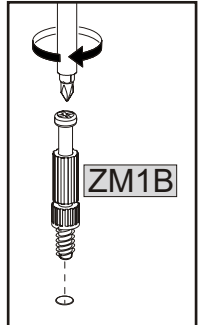
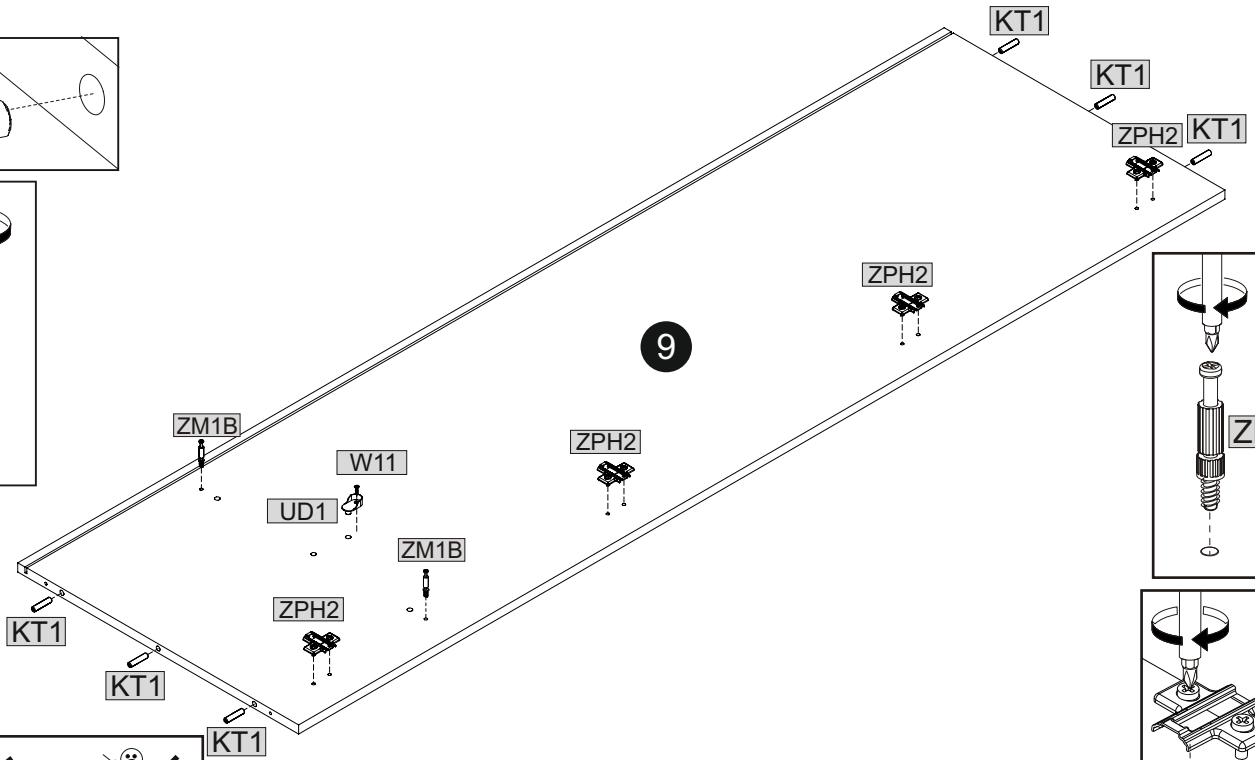
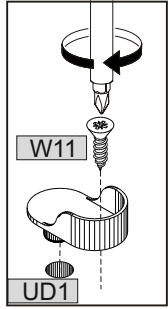
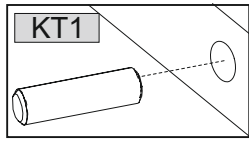

01

	8x35			3,5x16					
KT1	6	ZPH2	4	W11	1	UD1	1	ZM1B	2

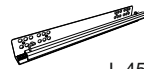

02

	8x35			3,5x16			L-450		6,3X13				
KT1	6	ZPH2	3	W11	1	UD1	1	PQFR	2	ME3	4	ZM1B	4

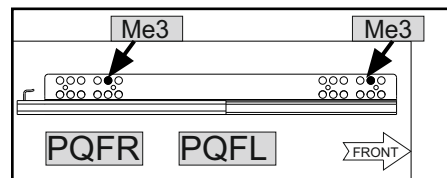
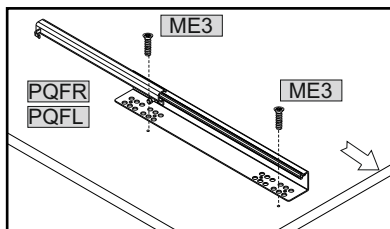
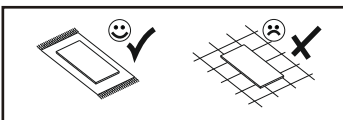
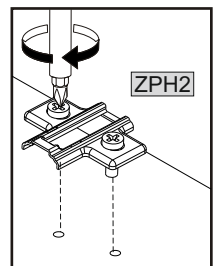
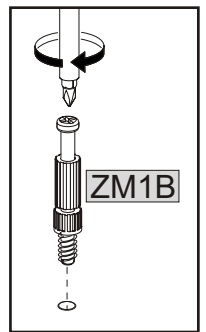
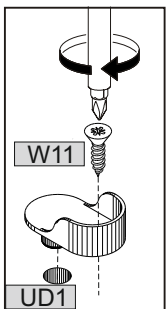
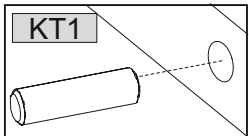
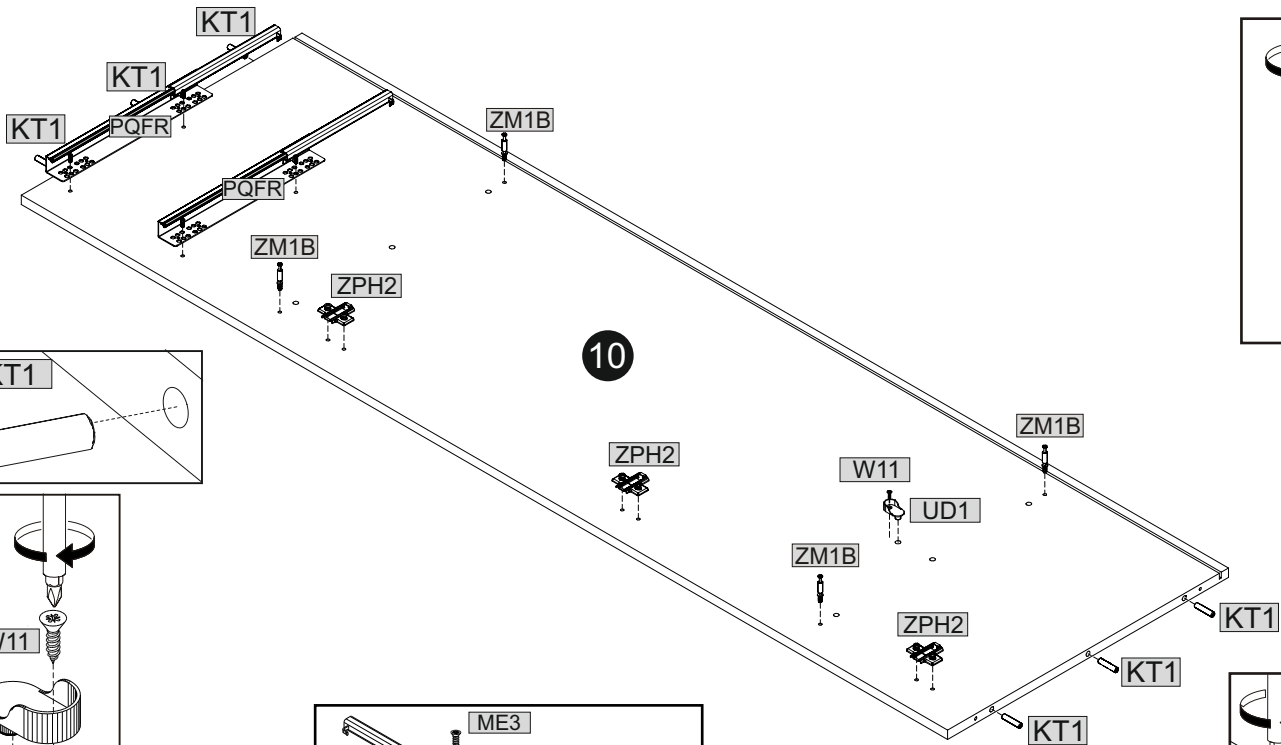



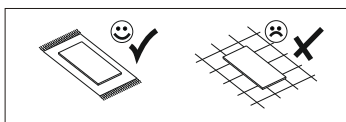
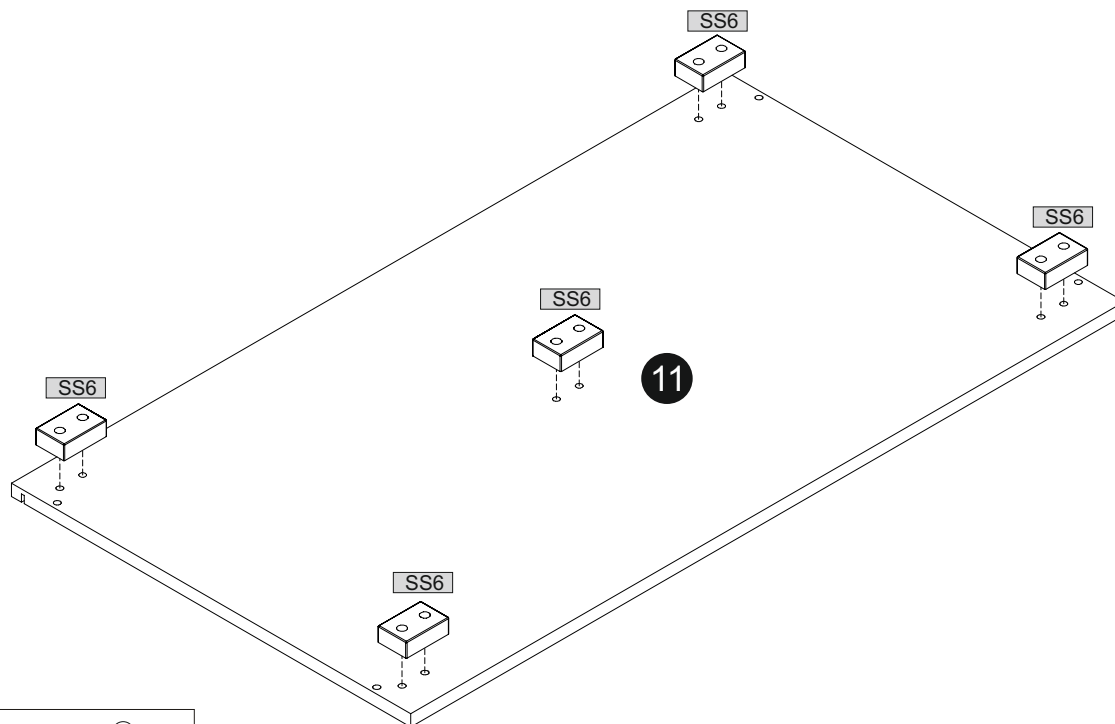

03

	
SS6	5

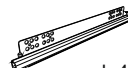

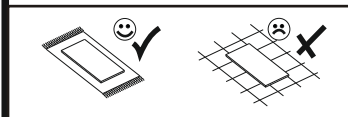
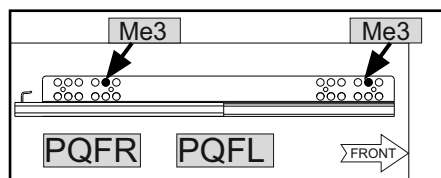
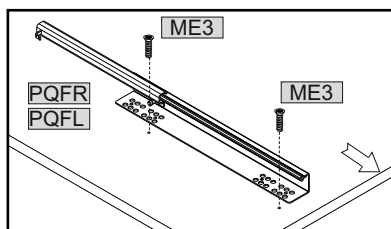
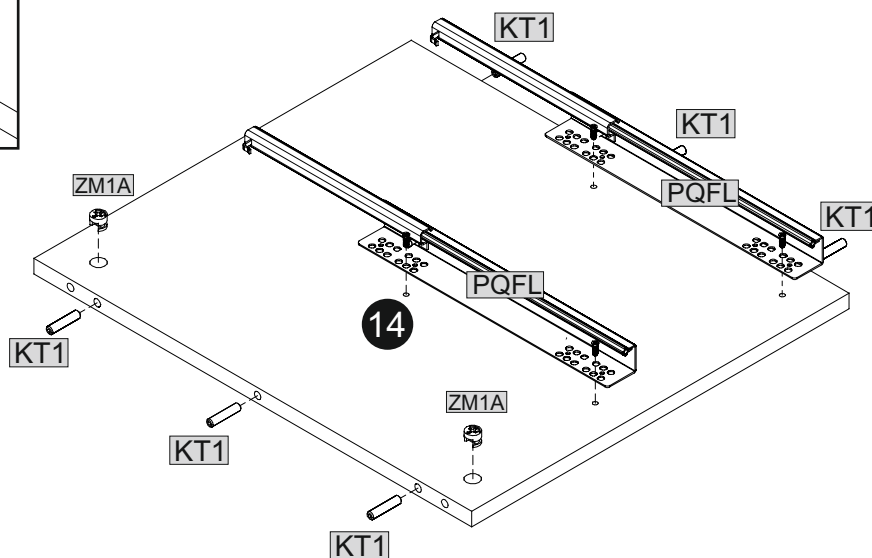
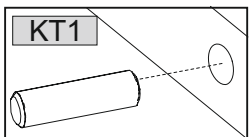
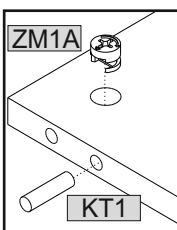
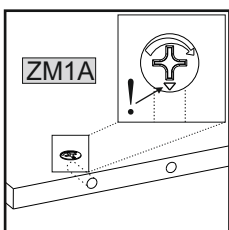

04

	L-450		6,3X13		8x35		
PQFL	2	ME3	4	KT1	6	ZM1A	2



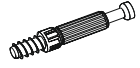

05

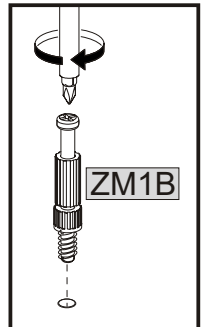
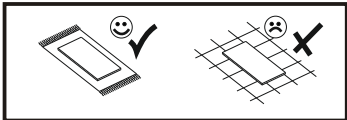
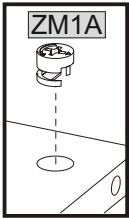
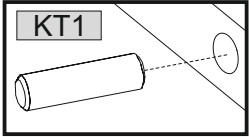
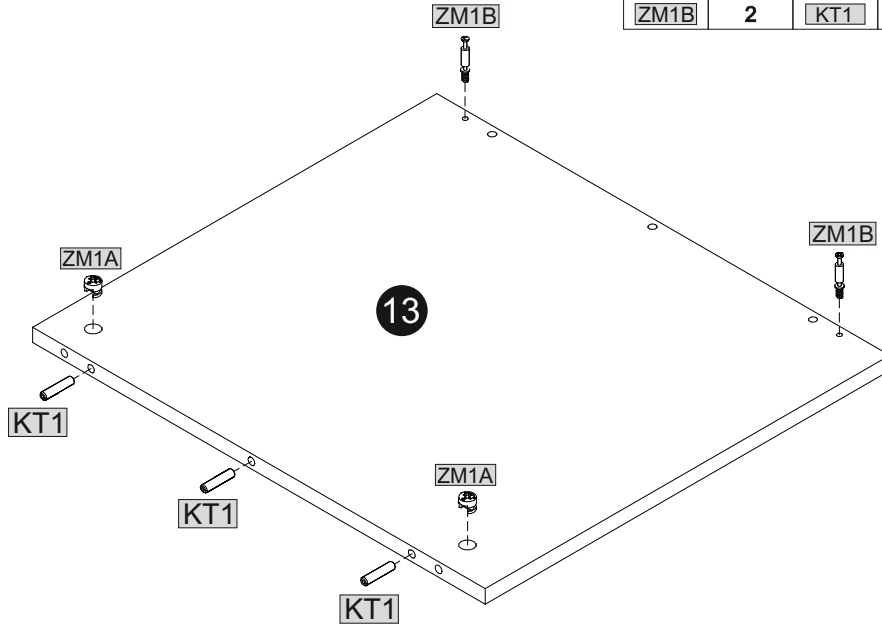
		
ZM1B	2	KT1
		8x35
		3
		ZM1A
		2
		15x15



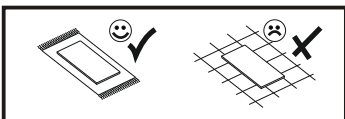
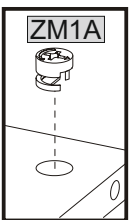
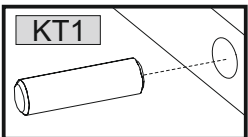
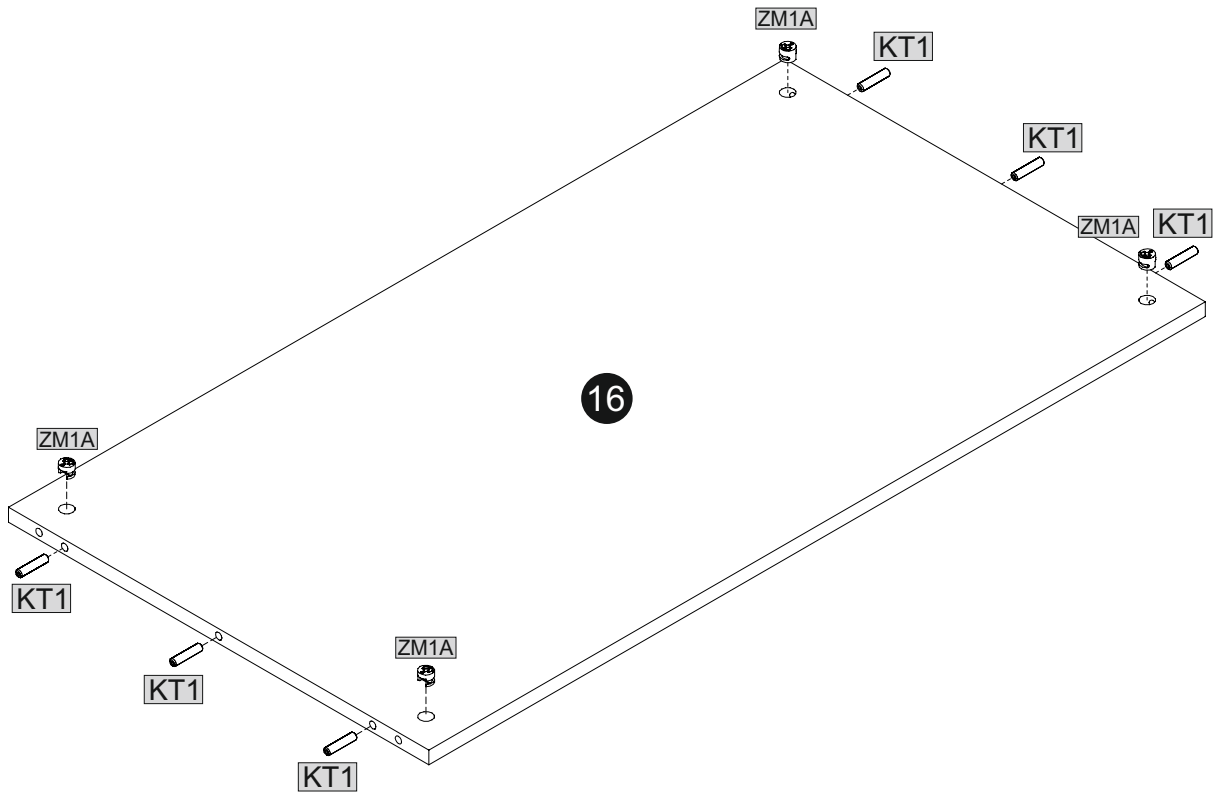

06

	
KT1	ZM1A
	8x35
	6
	4
	15x15



07

	4x13		
W4	6	ZWP	3

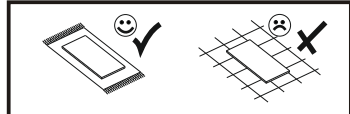
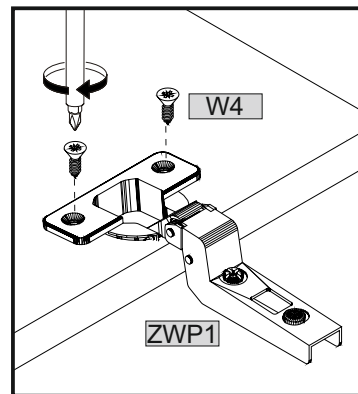
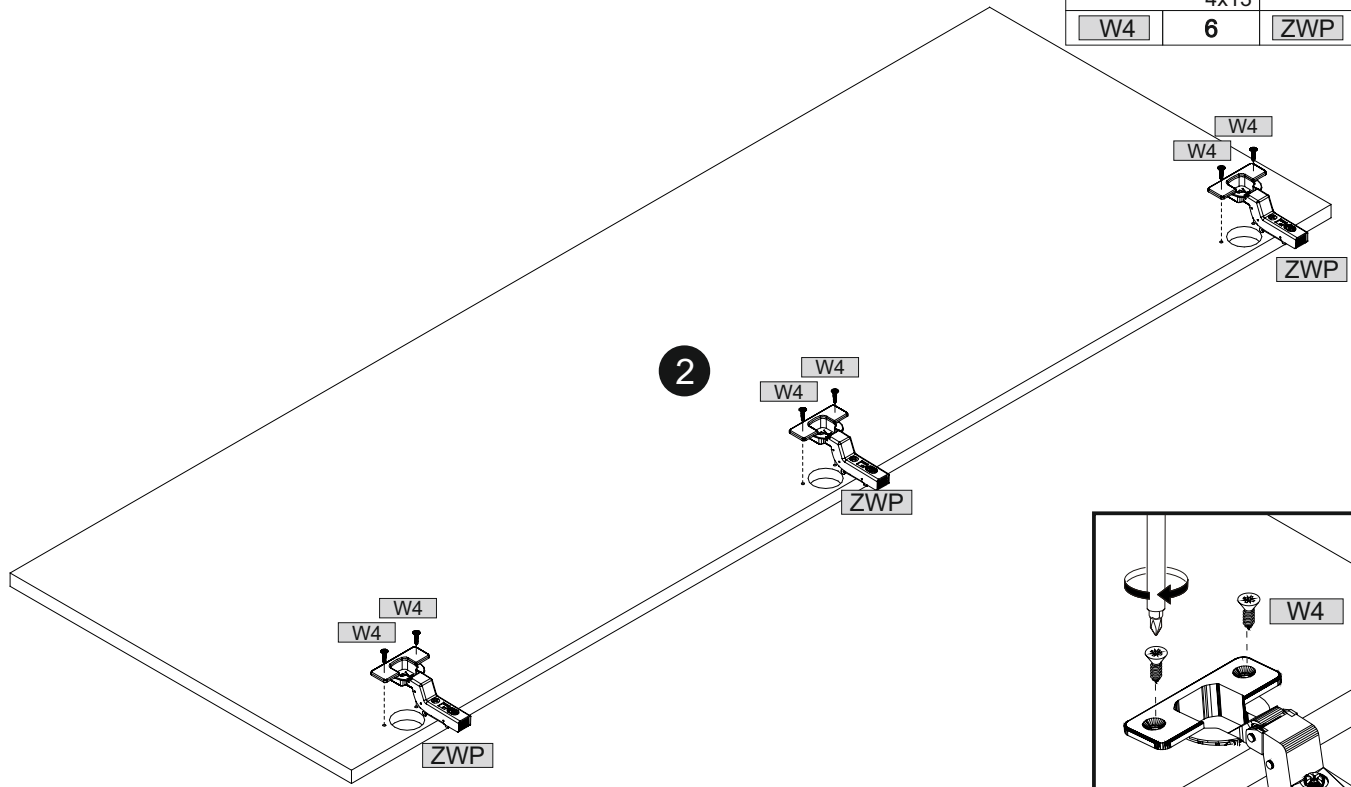

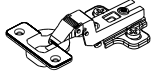

08

	4x13		
W4	8		

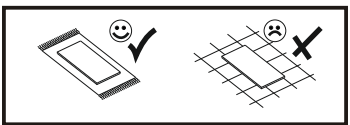
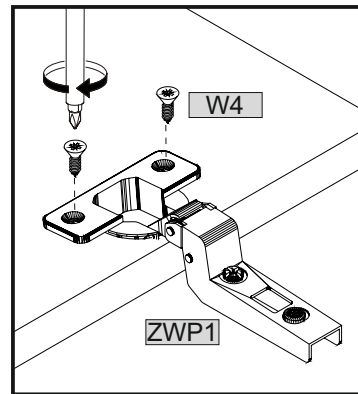
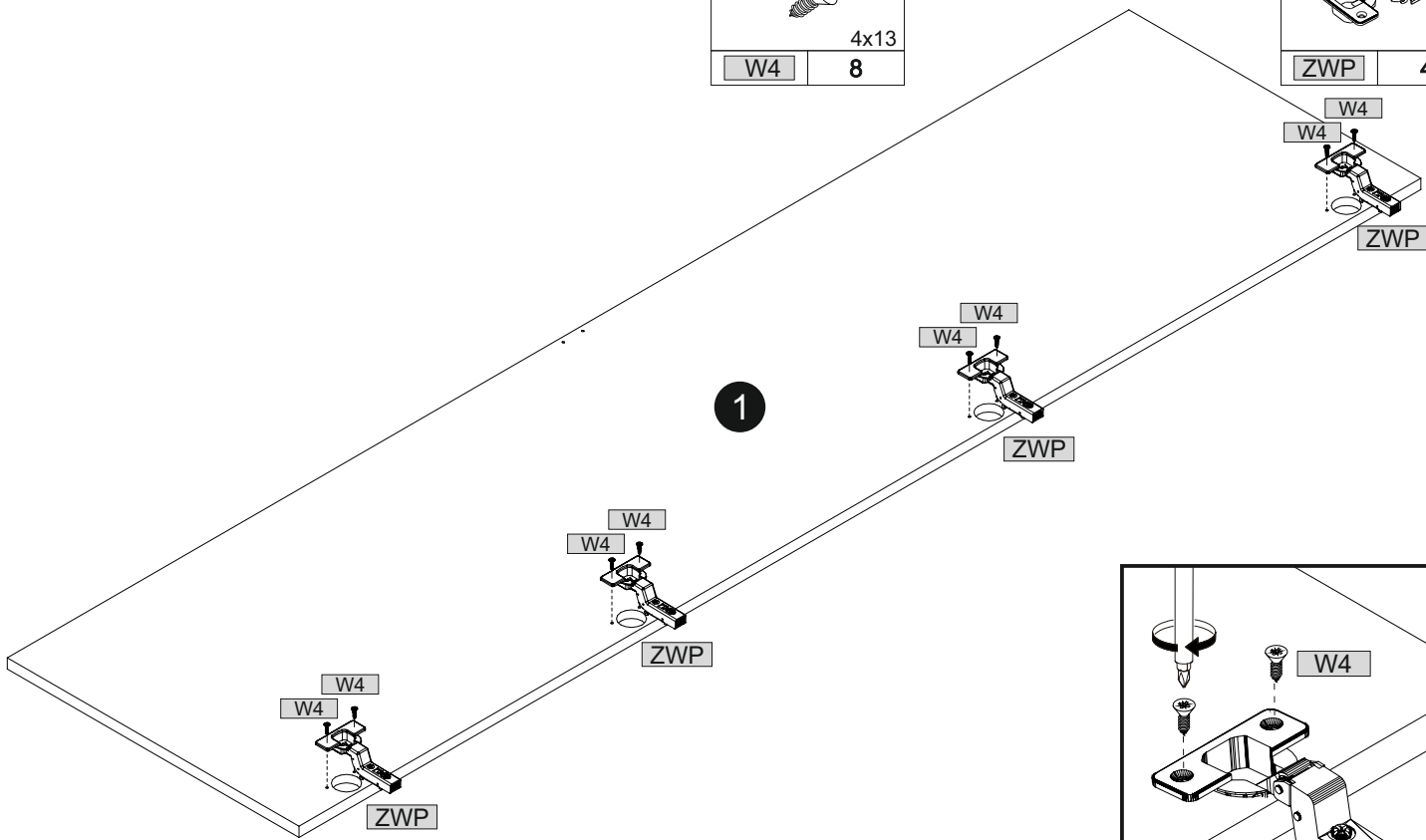
			
ZWP	4		



09

	8x35		15x15
KT1	12	ZM1A	4

x2

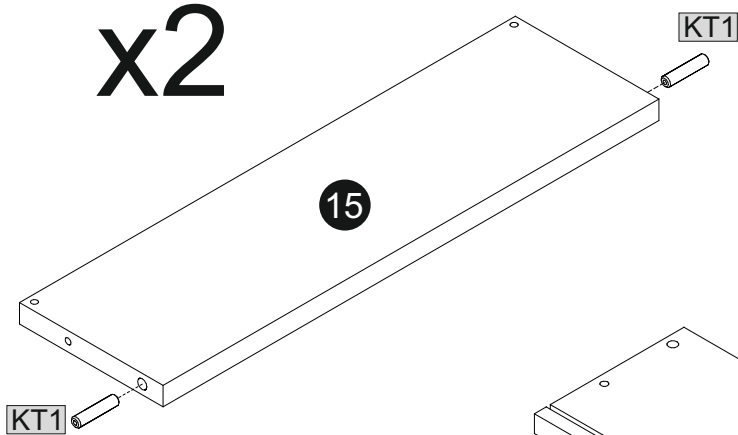

x2

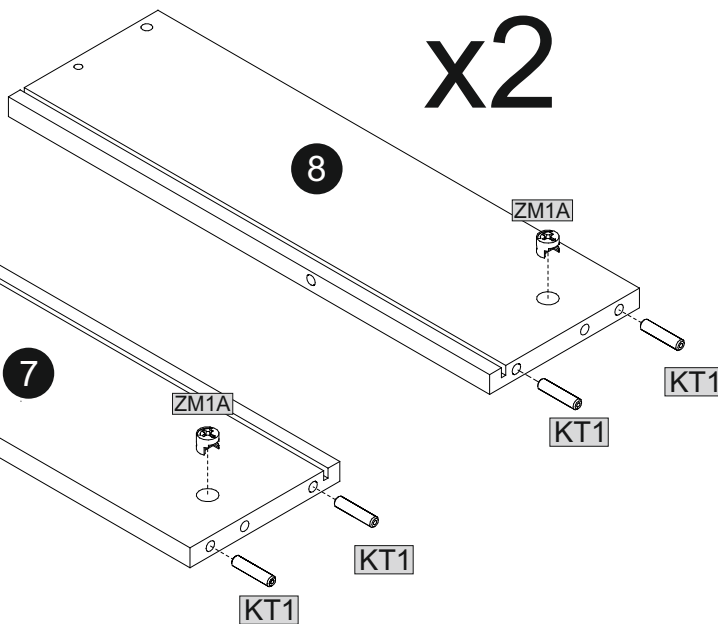

x2

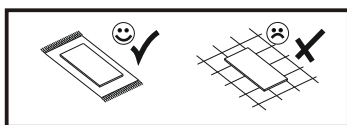
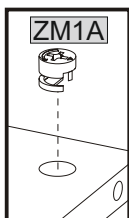
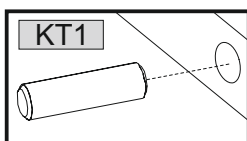
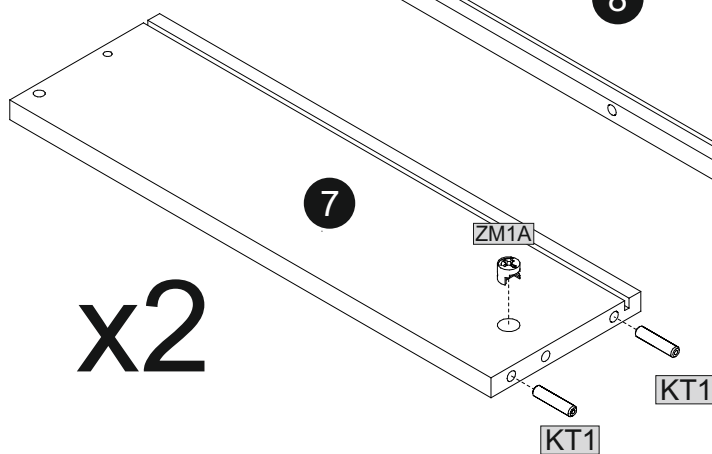

10

x2

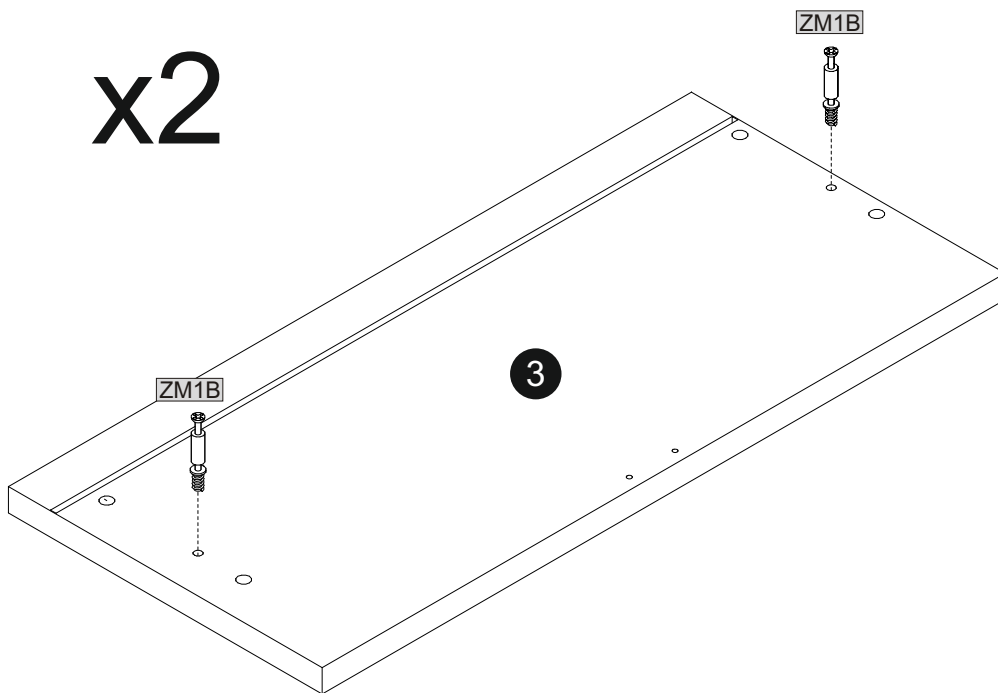

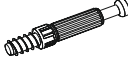
	
ZM1B	4

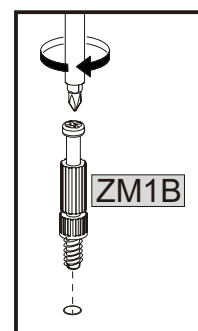
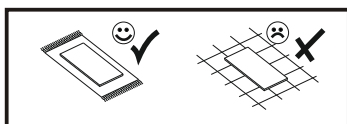

11

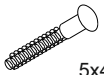
	
5x42	
KM1	4

x2

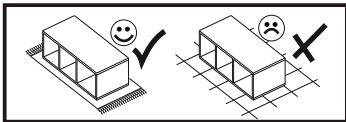
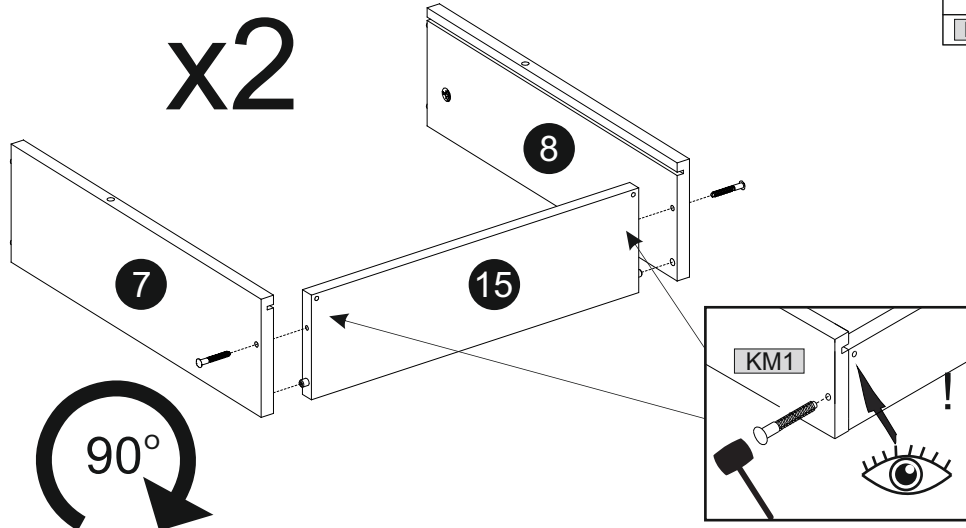

12

	
ZM1	4

x2

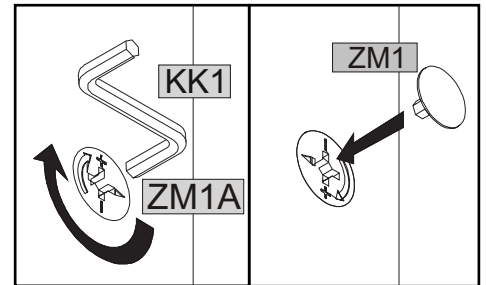
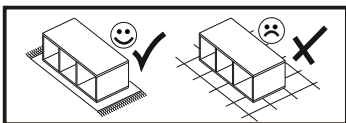
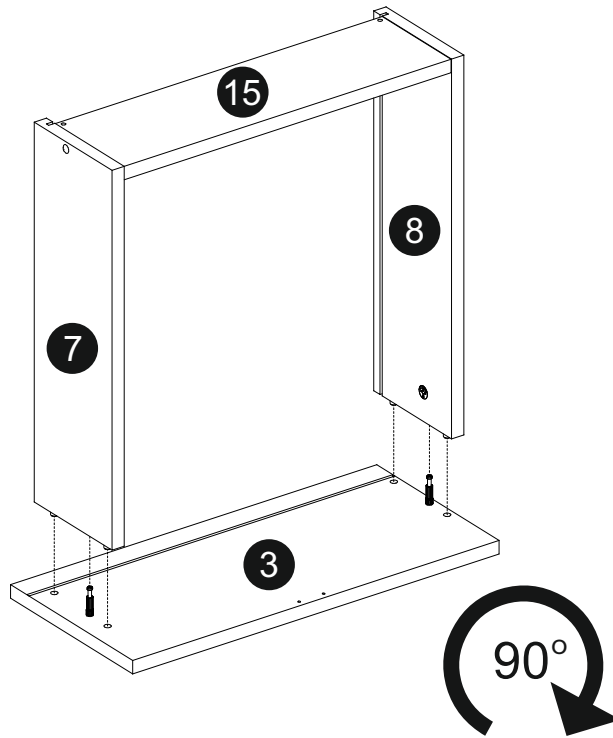

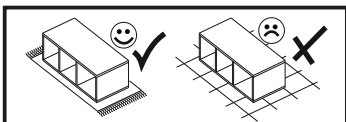
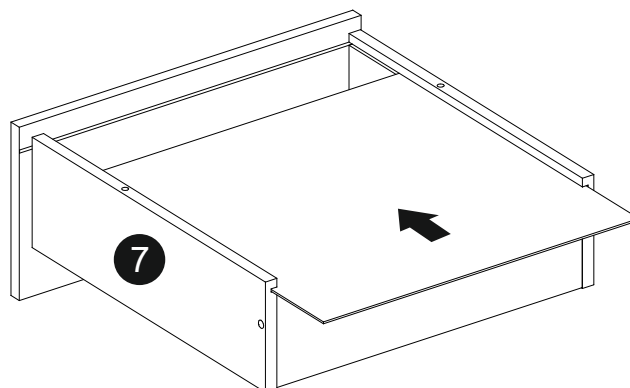

13

x2



14

	3x16		
W1	8	S1	2

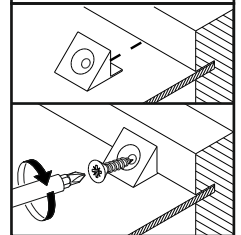
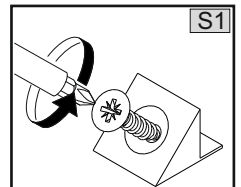
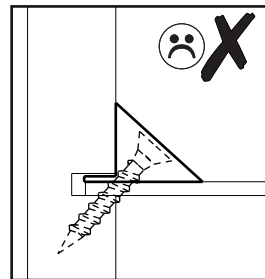
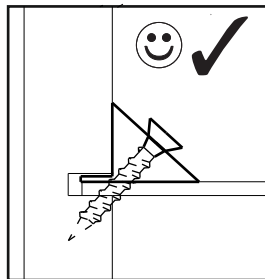
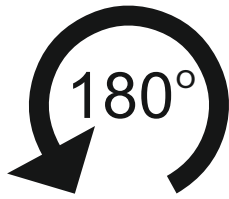
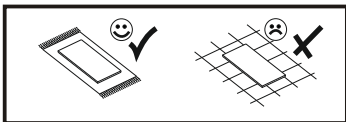
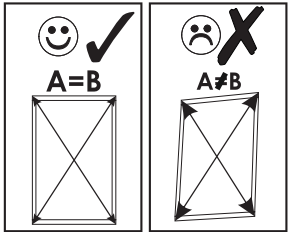
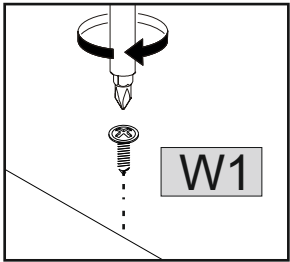
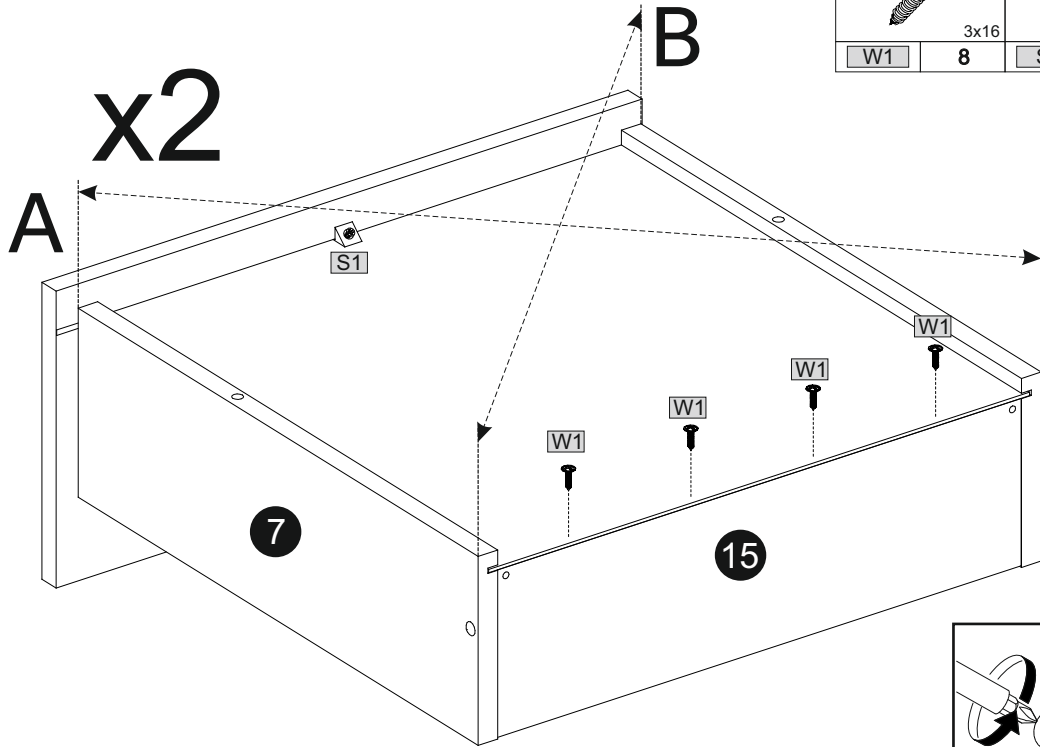

15

	
U71	2

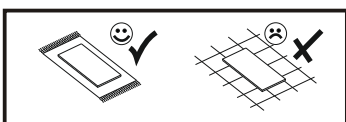
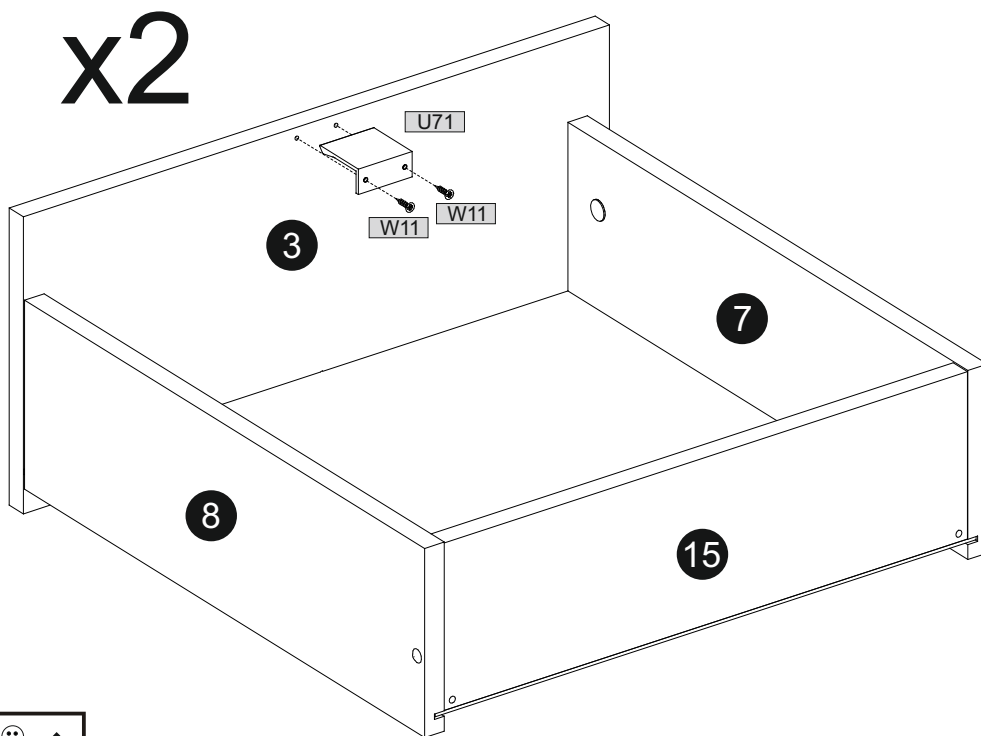

16

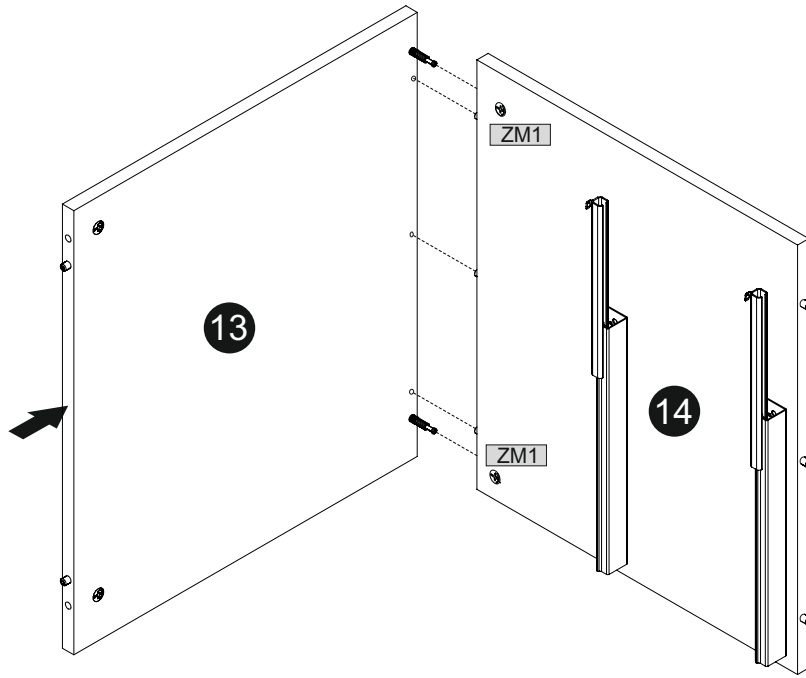

ZM1	2

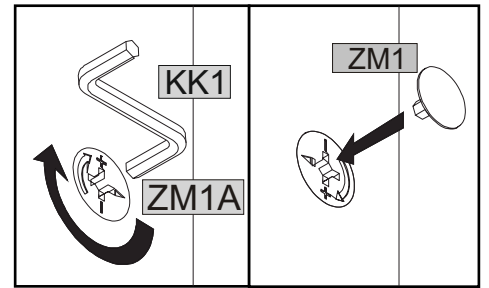
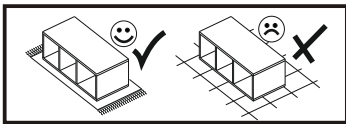

17

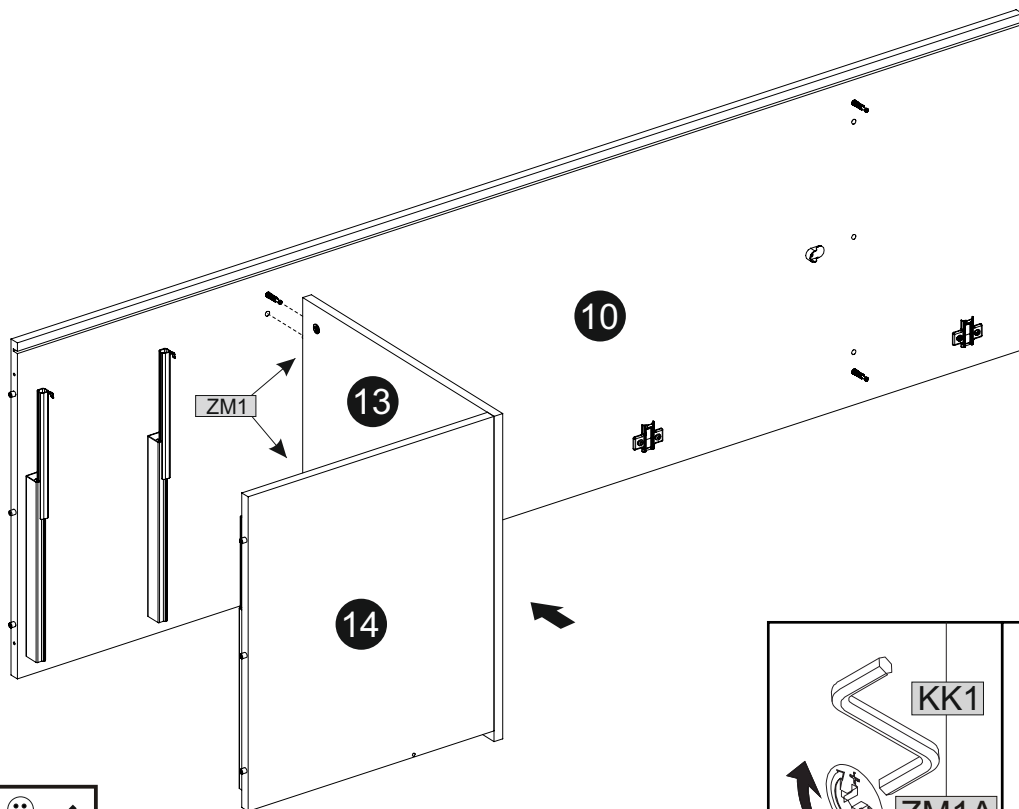

ZM1	2

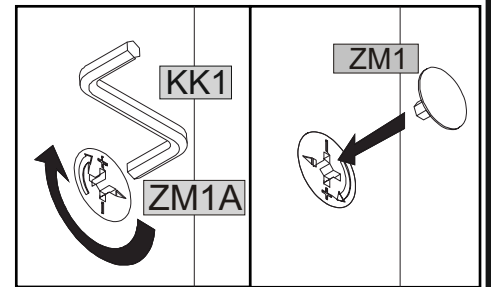
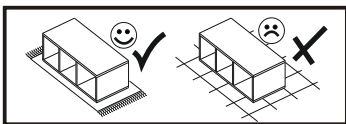

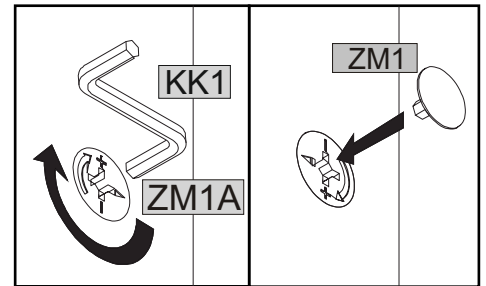
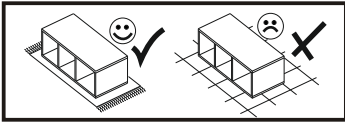
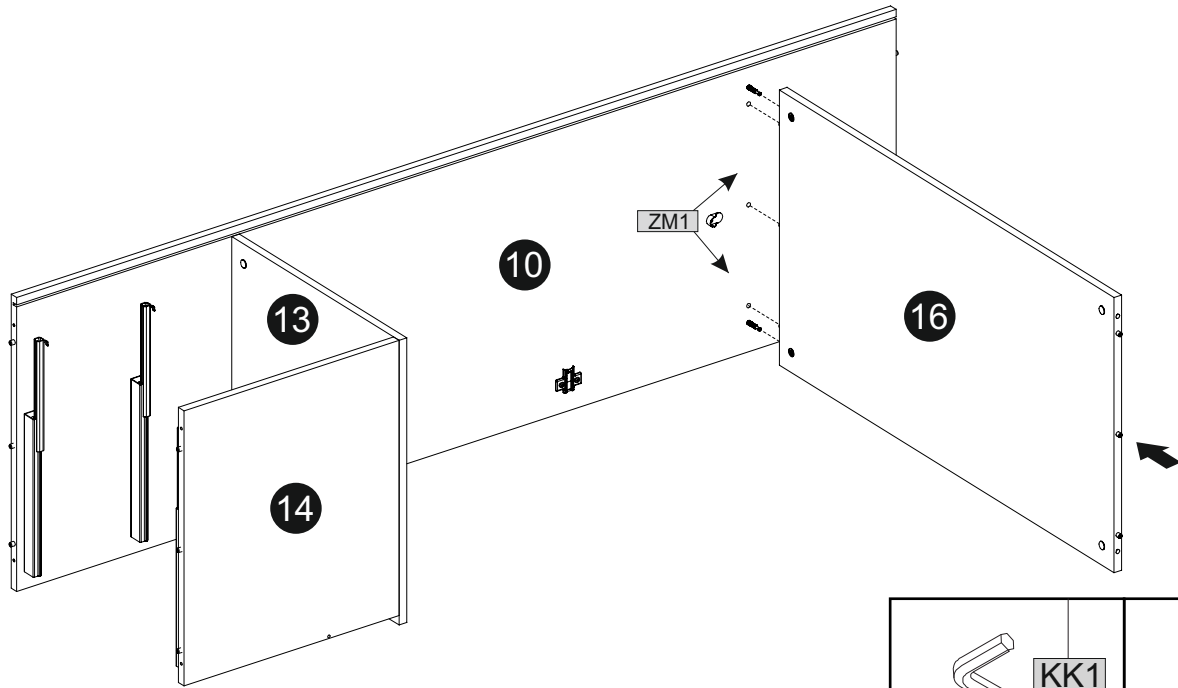
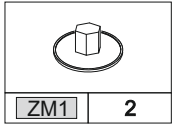

18

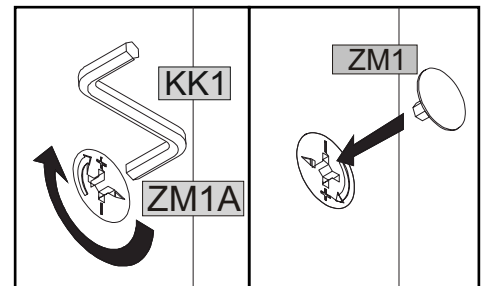
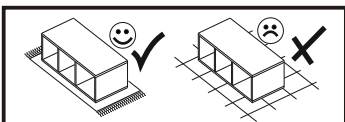
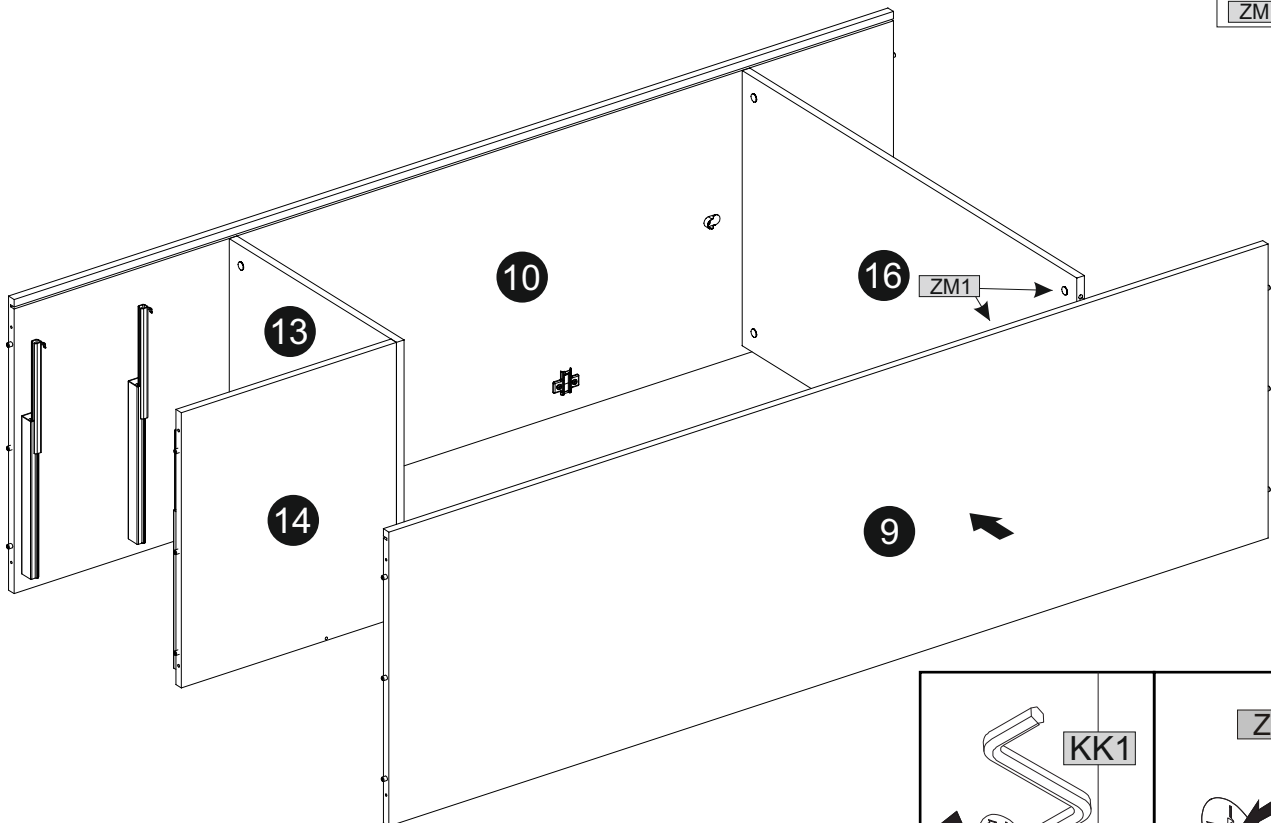
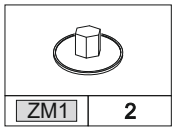

19

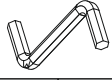

20

	KK1	1		K1	6	7x50
---	-----	---	---	----	---	------

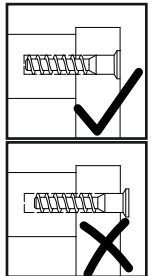
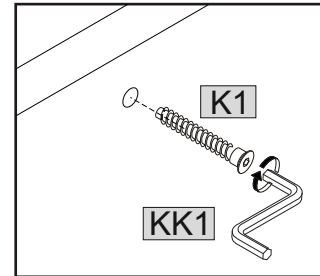
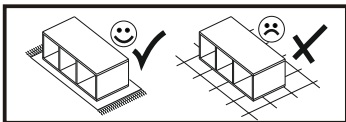
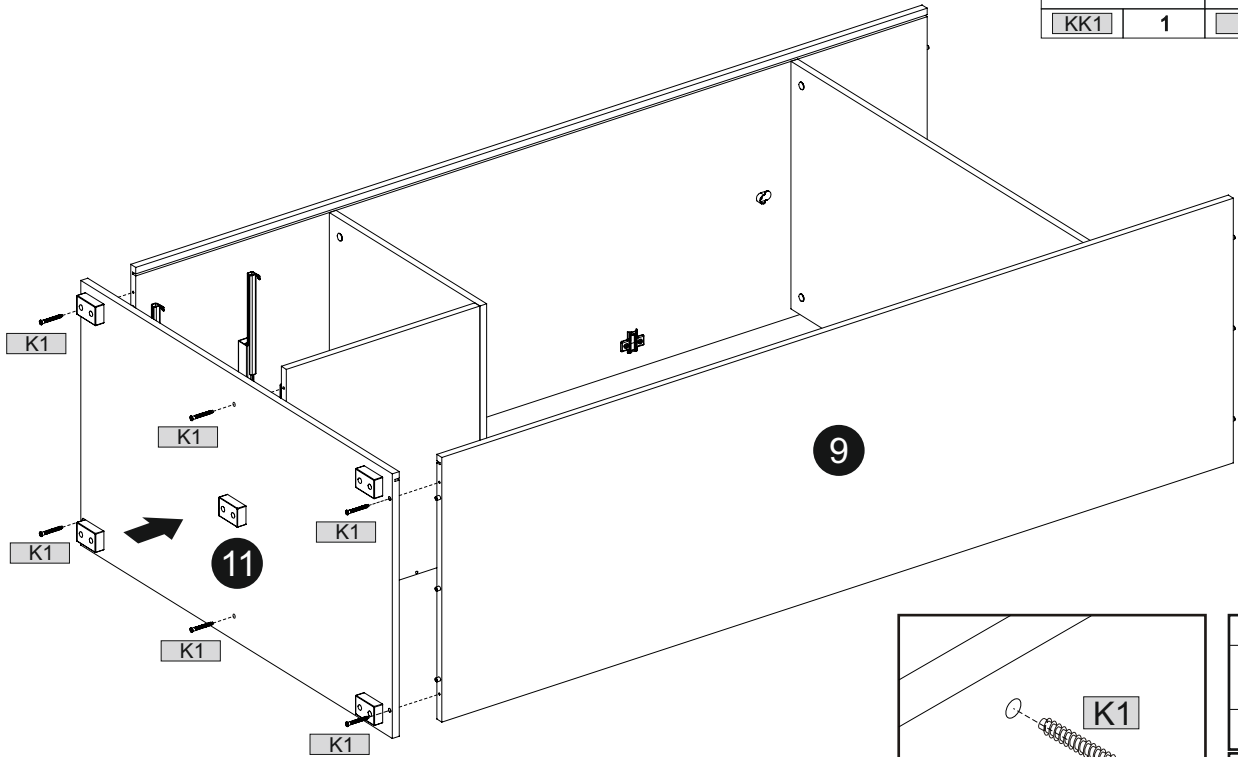

21

	L-1379	LI	1
---	--------	----	---

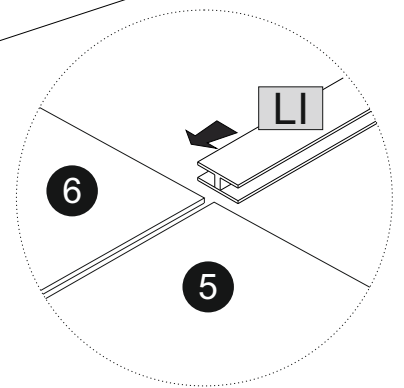
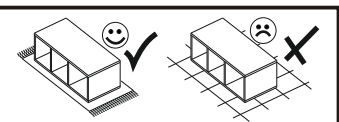
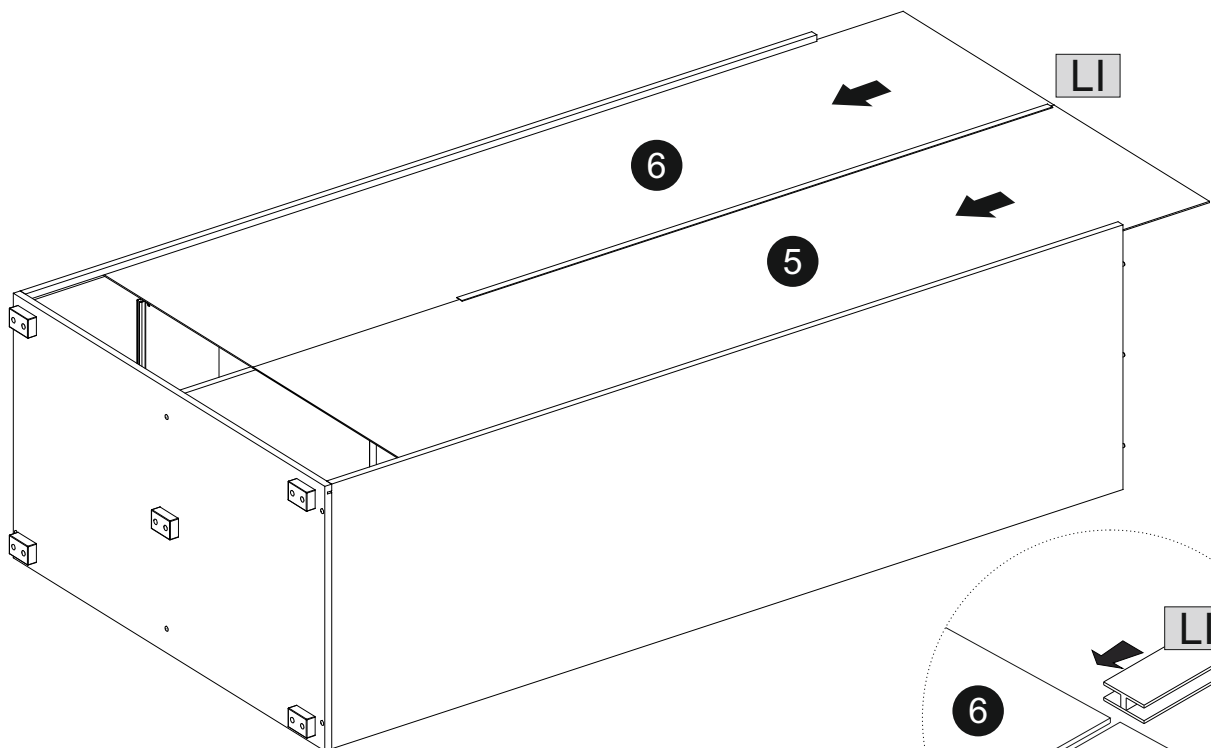

22

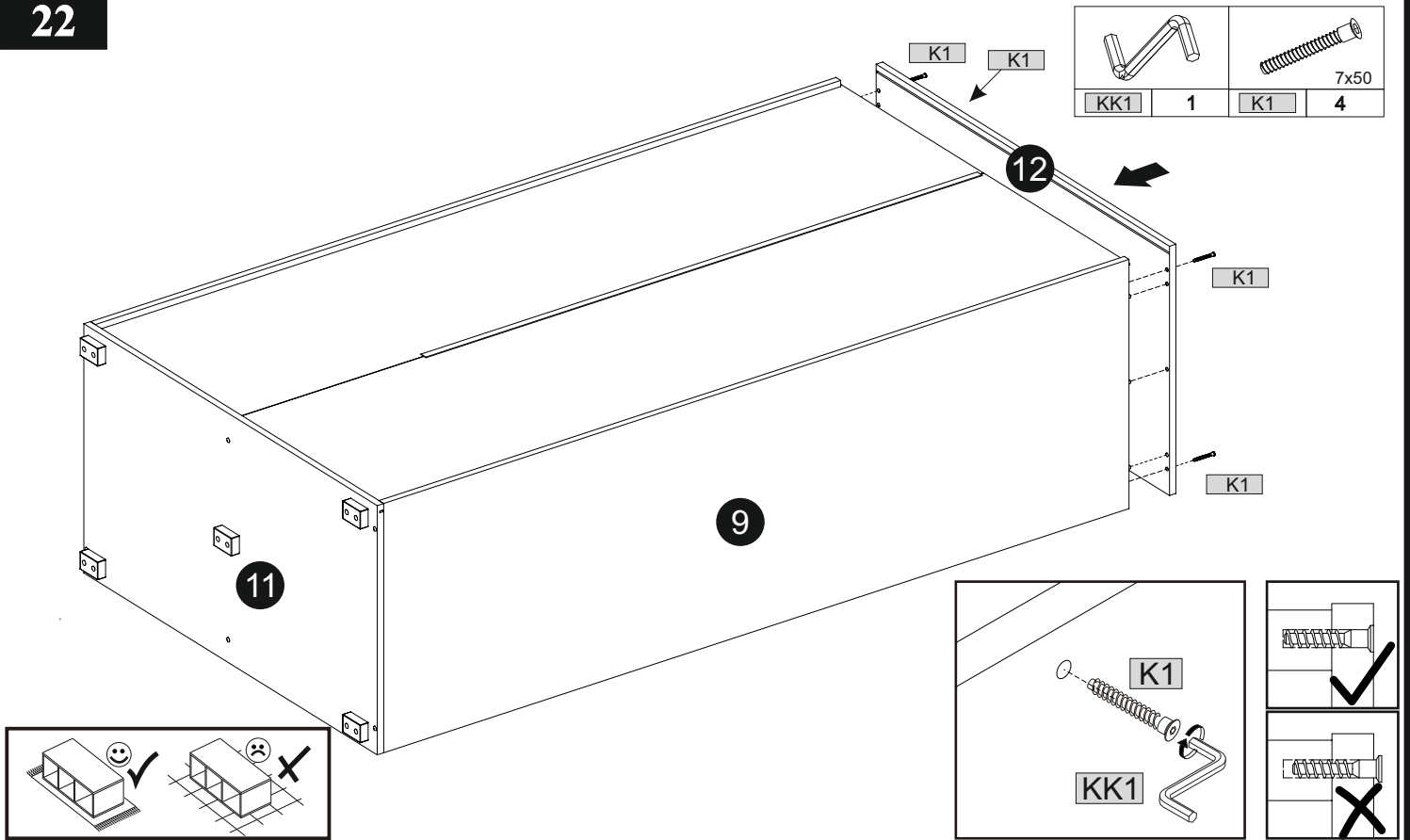

23

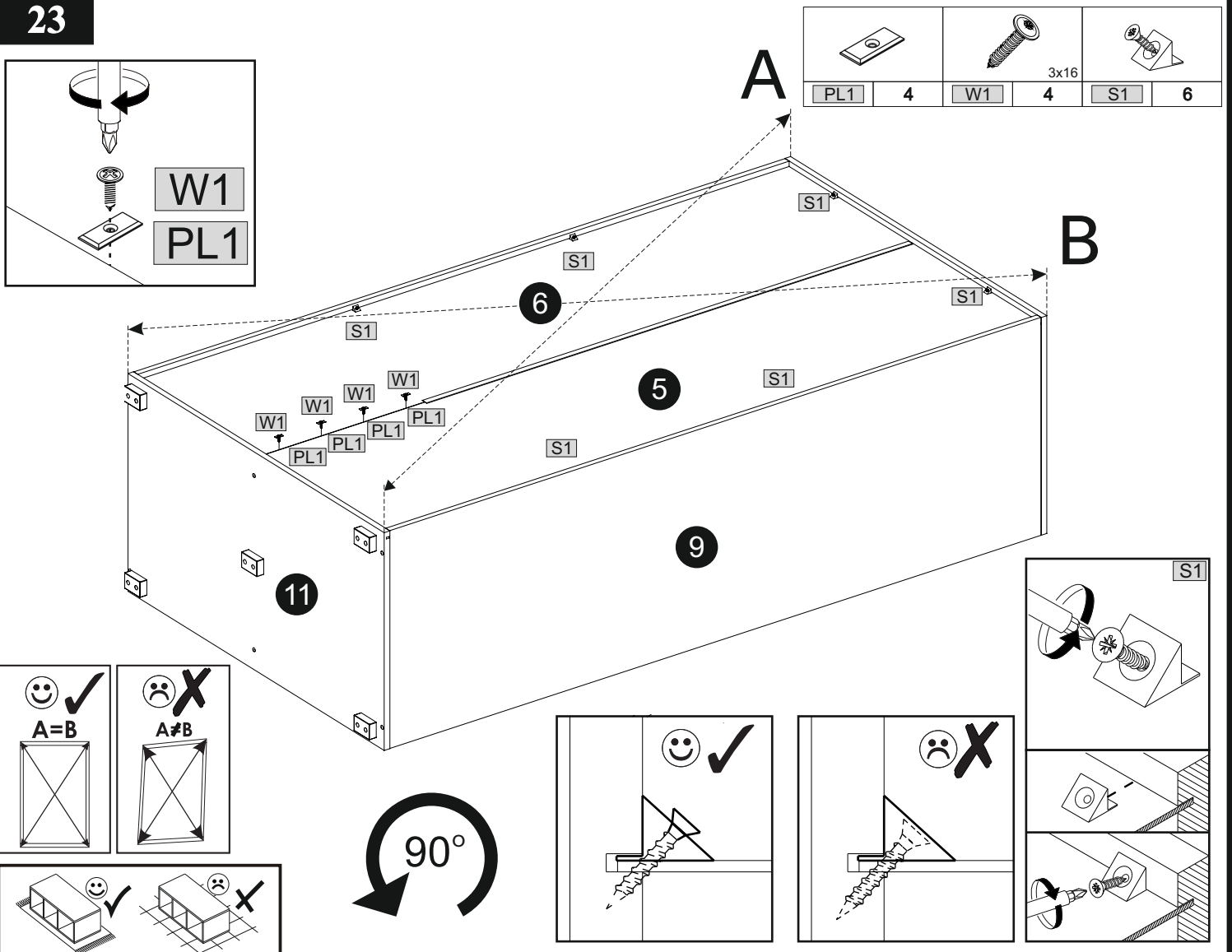

24

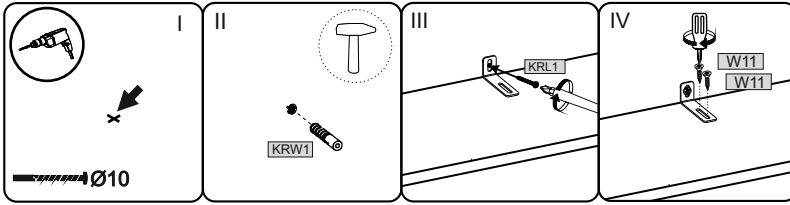

	2		2		1
	1		1		1
	4		1		1

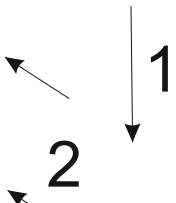
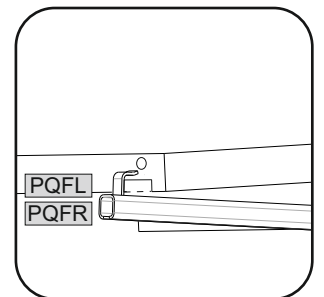
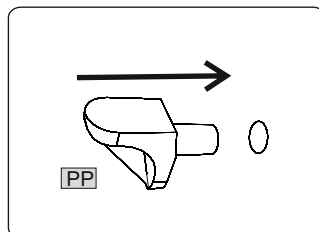
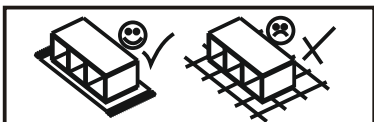
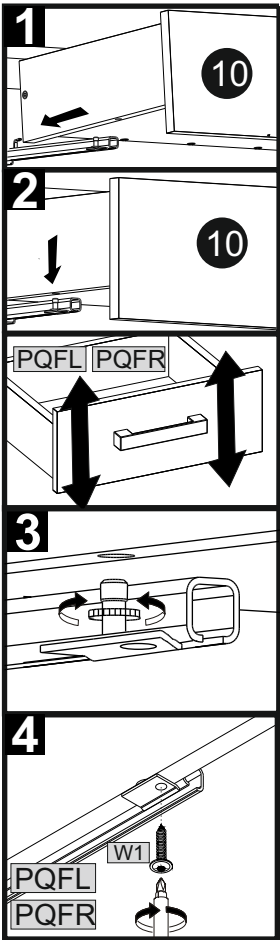
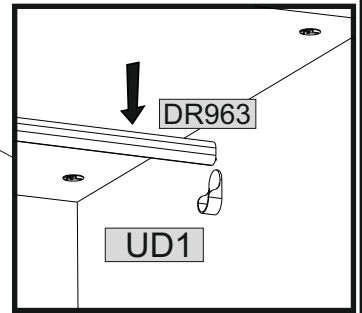
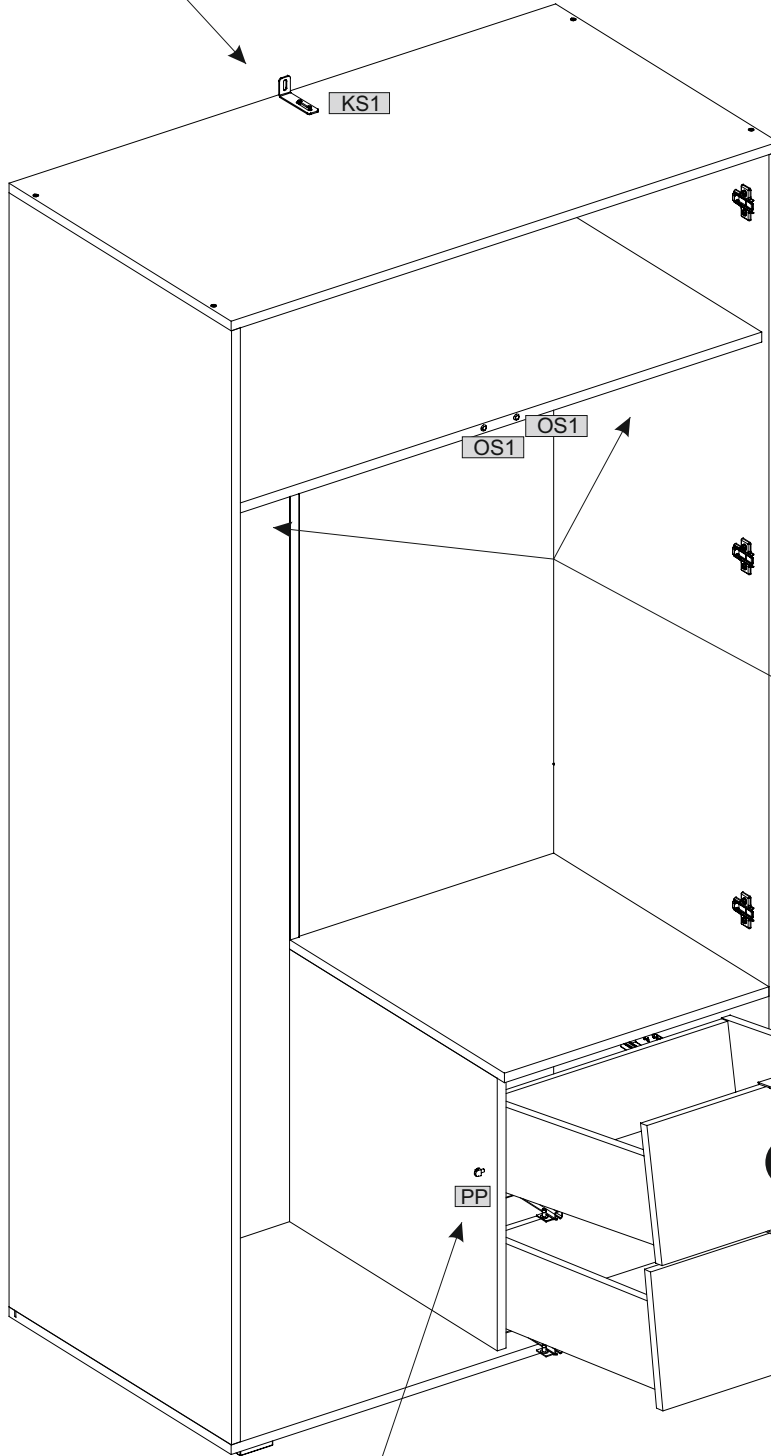

25

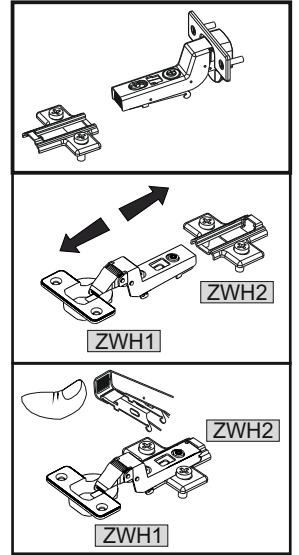
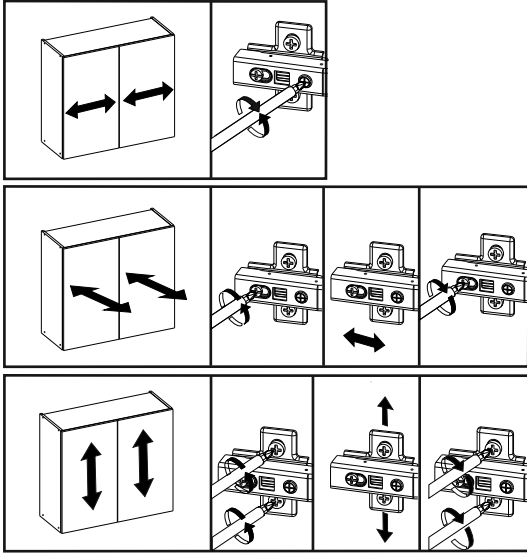
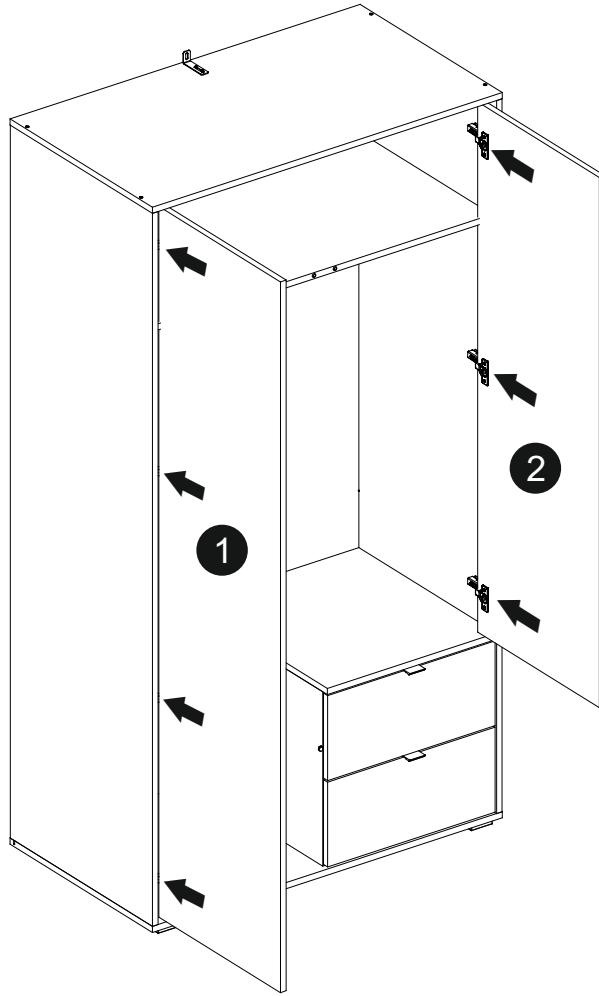

26

