

ROMA SZAFKA NOCNA

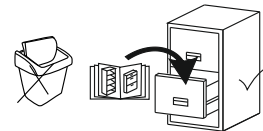

„MEBLE-OKMED” DEMKO - SPÓŁKA JAWNA
ul. Kolejowa 13, 14-500 Braniewo, POLSKA
www.mebleokmed.pl (+48) 55 243 27 26
firma@mebleokmed.pl

SERIA: .../...



ROMA SZAFKA NOCNA
SERIA:/..

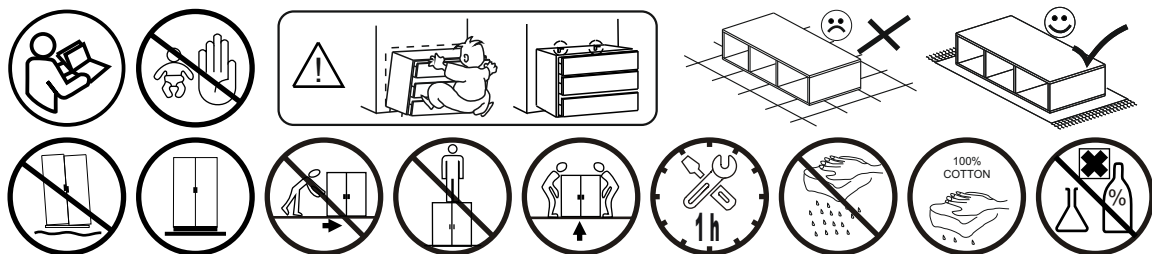
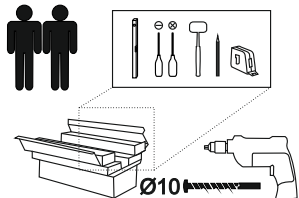
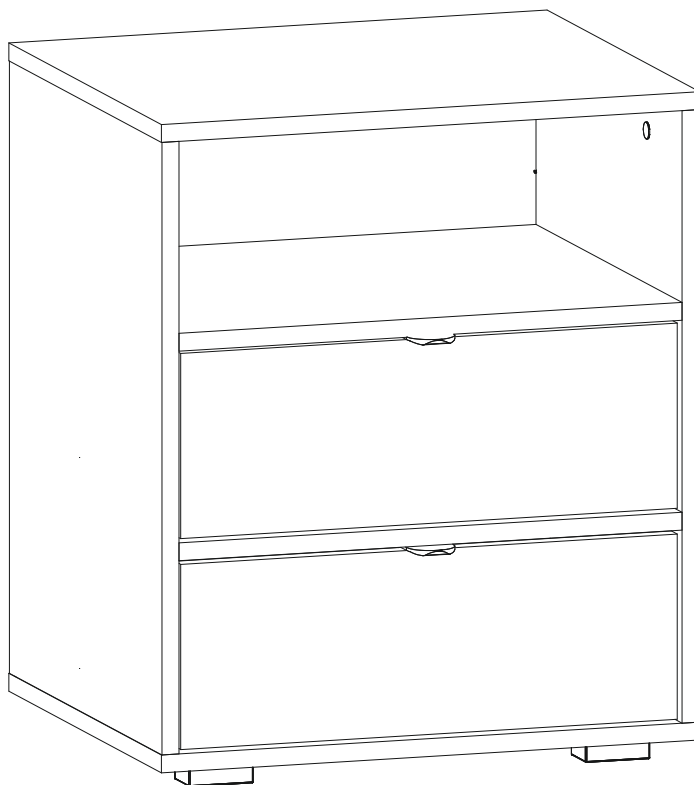
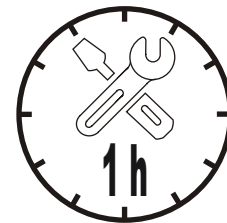



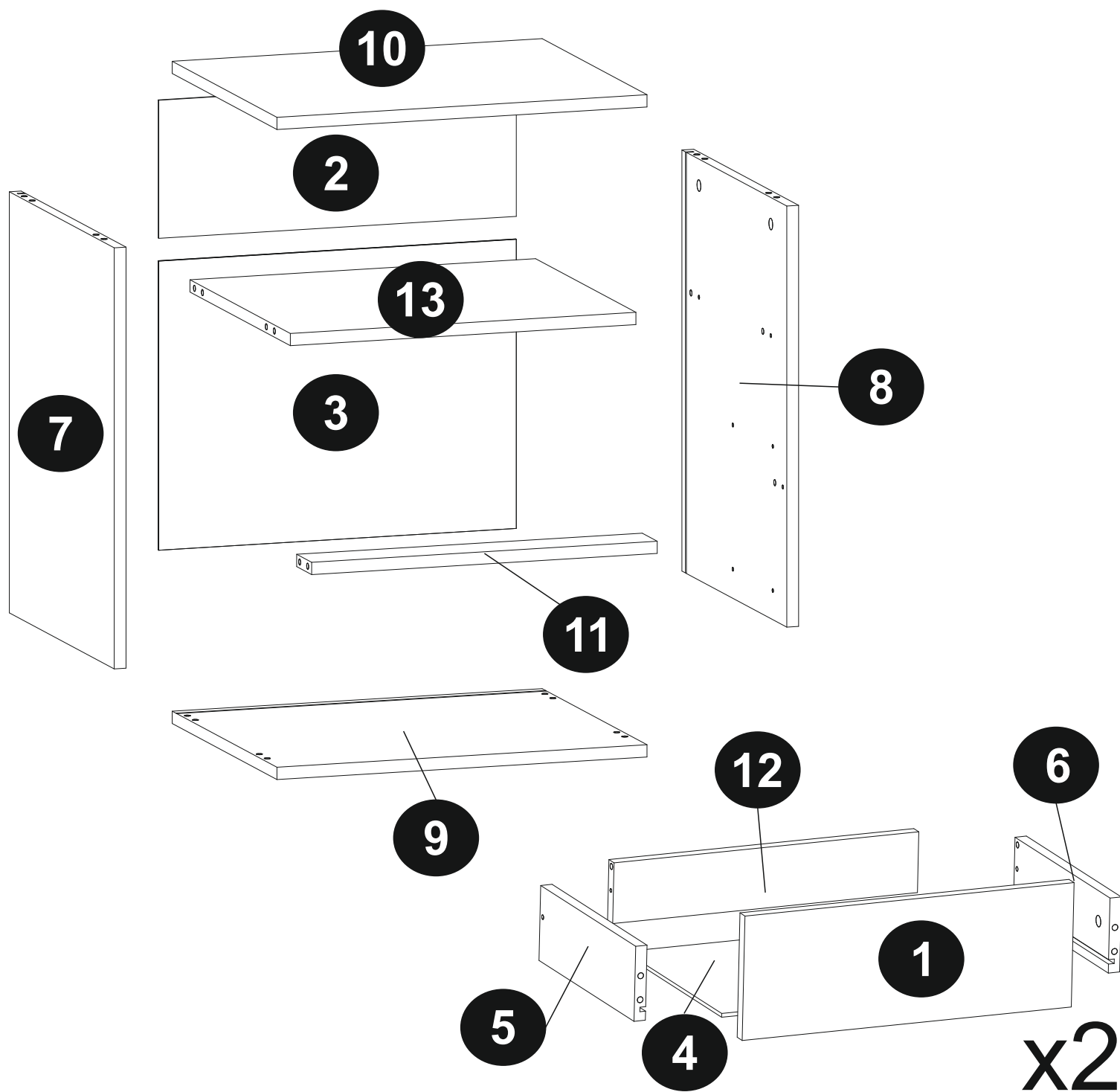

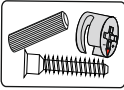



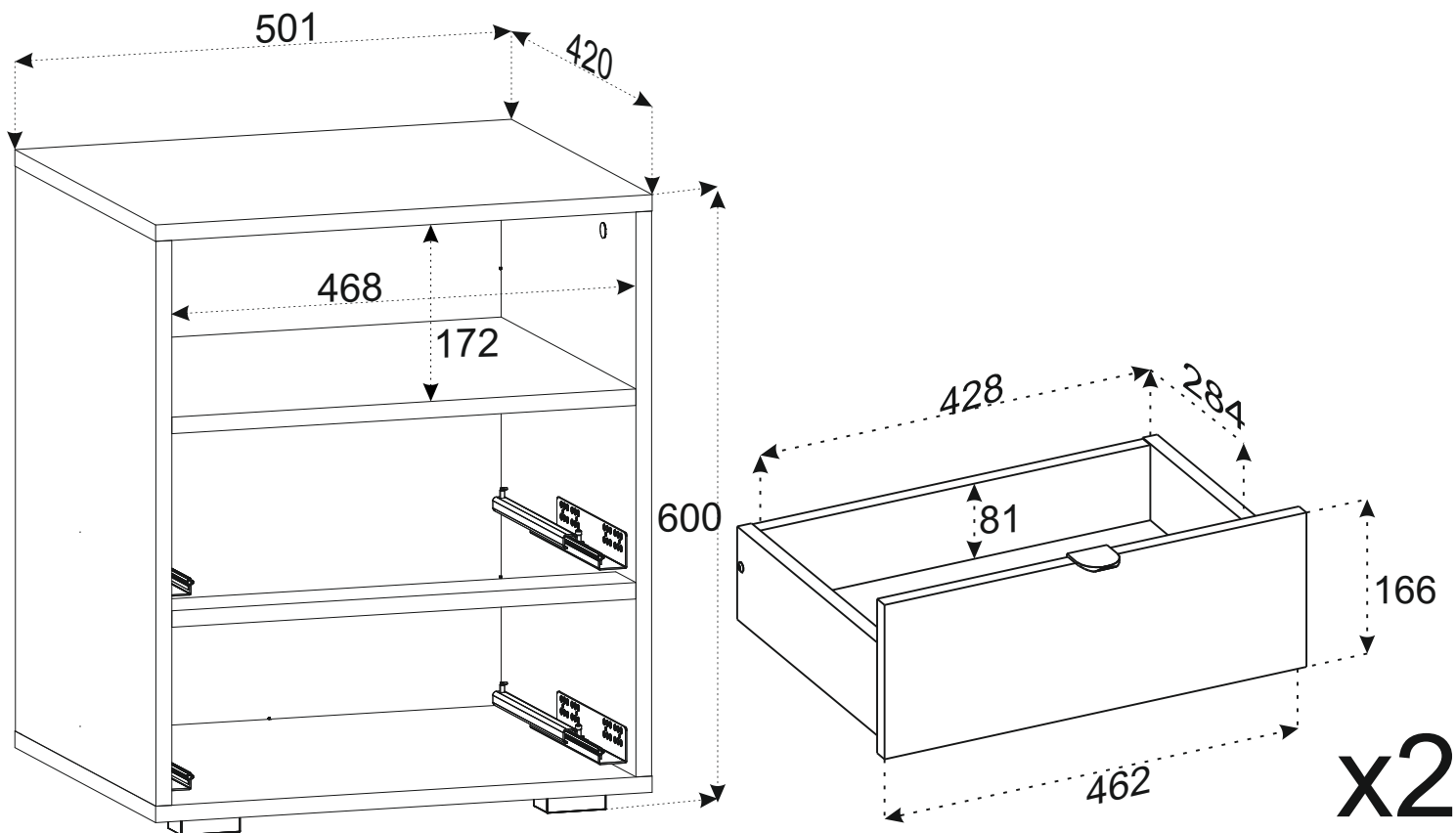









ROMA SZAFKA NOCNA



	N	L [mm]	W [mm]	T [mm]	Q	N	L [mm]	W [mm]	T [mm]	Q
		1	166	462	16	2	7	549	420	16
2		484	188	3	1	8	549	420	16	1
COLLI 1/1	3	377	484	3	1	9	501	420	16	1
	4	442	305	5	2	10	501	420	16	1
	5	300	100	16	2	11	468	60	16	1
	6	300	100	16	2	12	428	81	16	2
						13	468	402	16	1

ROMA SZAFKA NOCNA



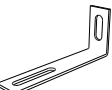

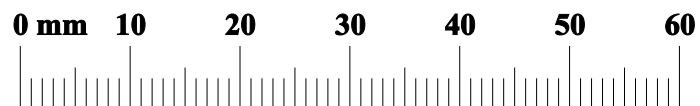

 3x16 W1 16	 3,5x16 W11 14	 15x12 ZM1A 14	 ZM1B 14	 6,3x13 ME3 8	 6x50 KRL1 1
 Ø8x35 KT1 22	 5x42 KM1 4	 10x50 KRW1 1	 6,4x50 K3 4	 UP 2	 SS6 4
 ZM1 8	 Ø4 KK1 1	 S1 8	 PL1 4	 L=300 PQ3 2	 L=300 PQ4 2
 KS1 1					





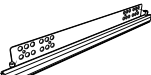

ROMA SZAFKA NOCNA

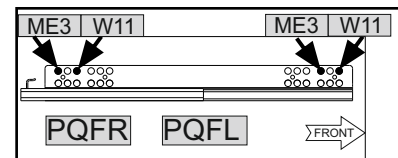
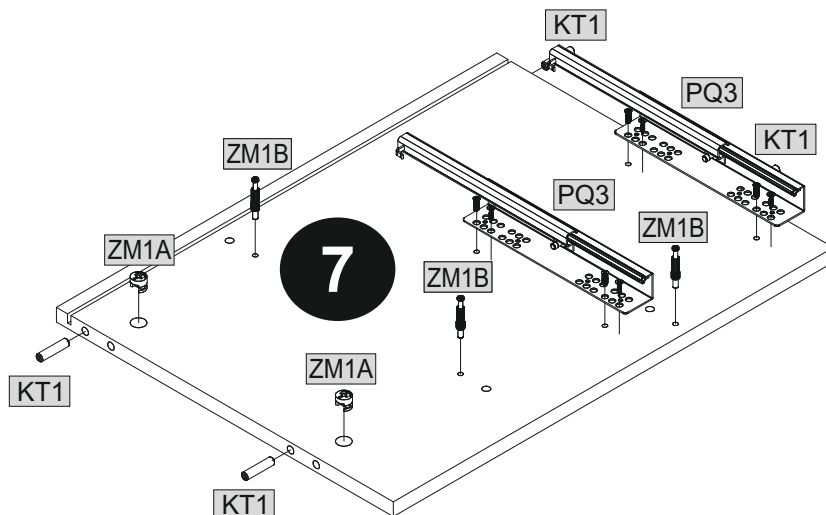
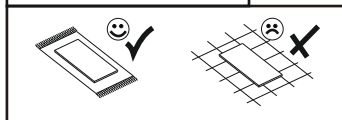
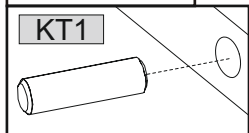
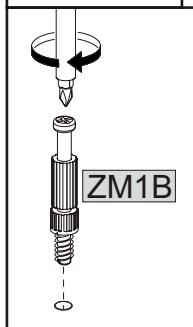
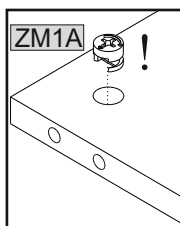
01

	$\varnothing 8 \times 35$		15x15				L=300		3,5x16		6,3x13
KT1	4	ZM1A	2	ZM1B	3	PQ3	2	W11	4	ME3	4

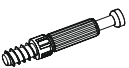
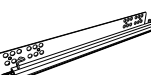

02

	$\varnothing 8 \times 35$		15x15				L=300		3,5x16		6,3x13
KT1	4	ZM1A	2	ZM1B	3	PQ4	2	W11	4	ME3	4

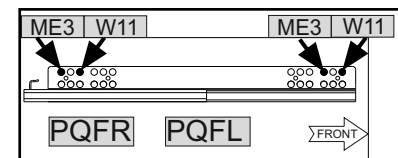
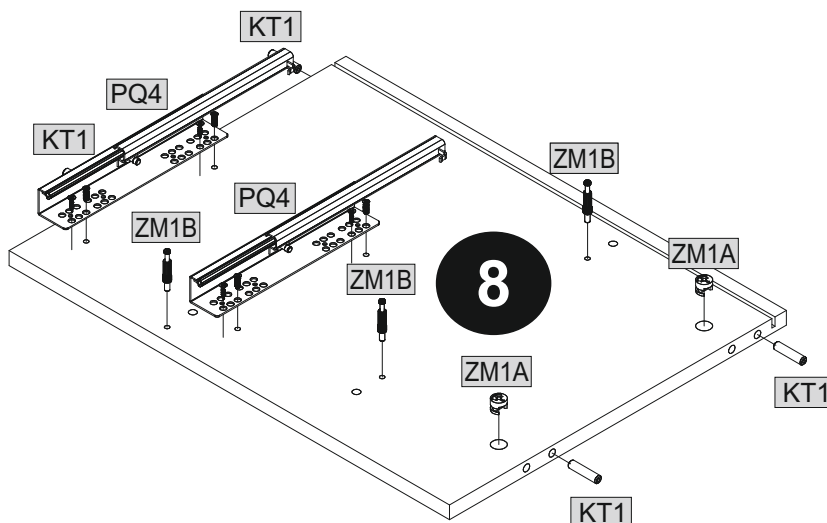
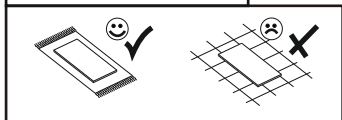
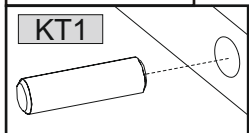
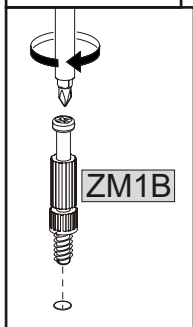
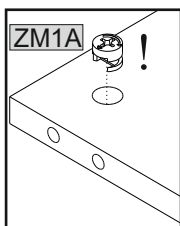

ROMA SZAFKA NOCNA

03

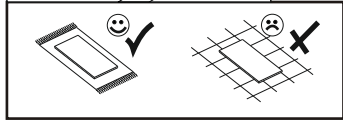
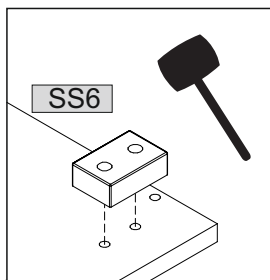
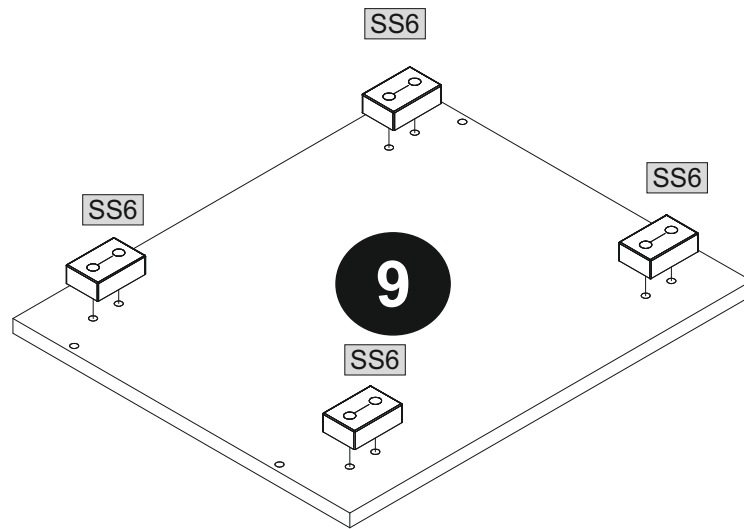
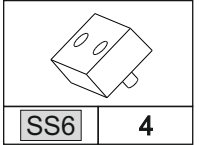

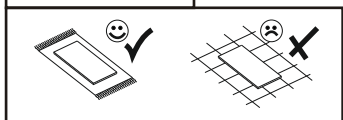
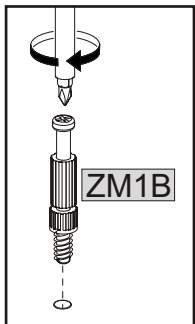
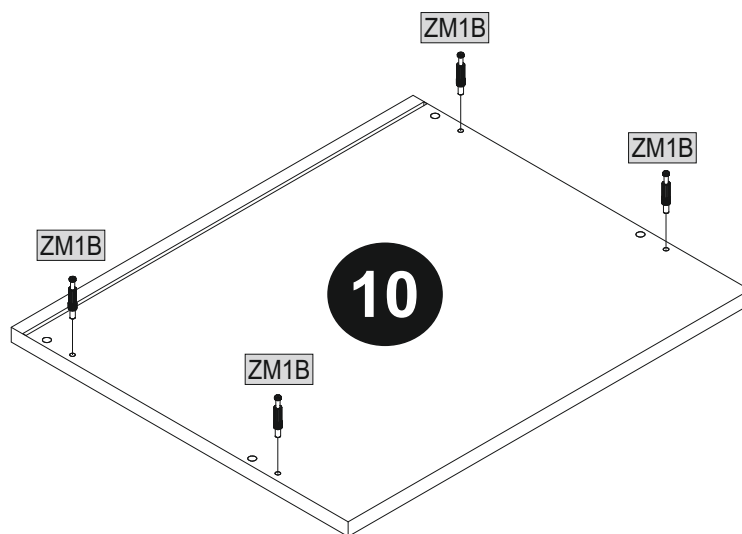
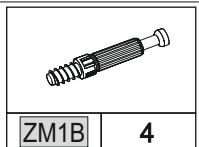

04





ROMA SZAFKA NOCNA

05

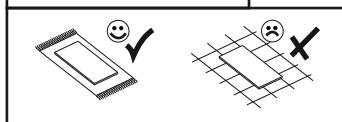
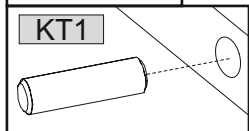
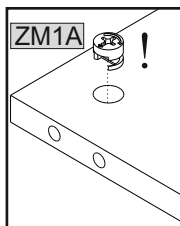
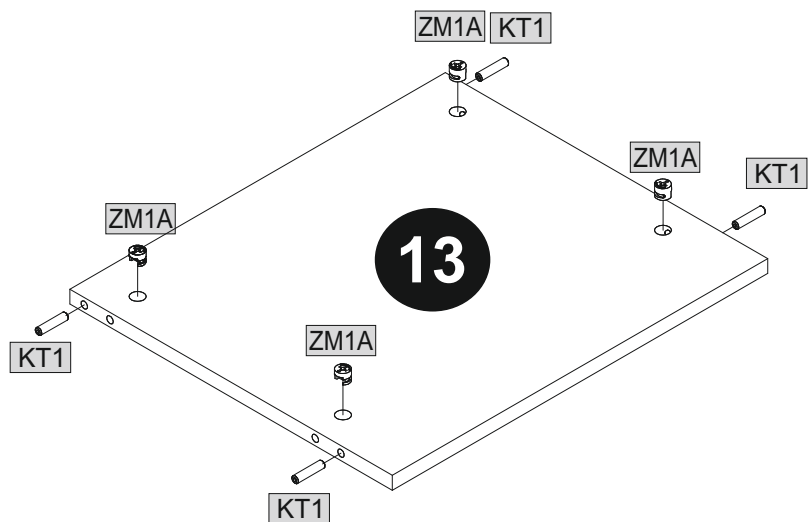
	15x15		Ø8x35
ZM1A	4	KT1	4



06

	15x15		Ø8x35
ZM1A	2	KT1	2

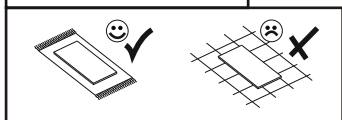
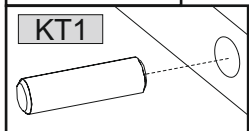
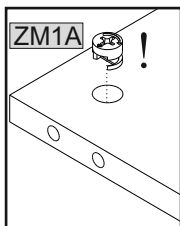
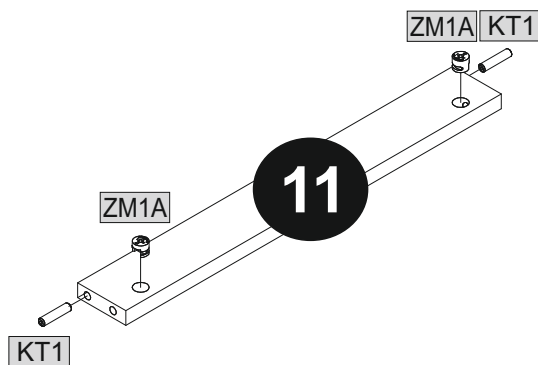

ROMA SZAFKA NOCNA

07

x2

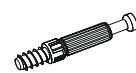

ZM1B

4

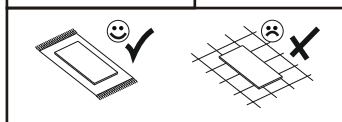
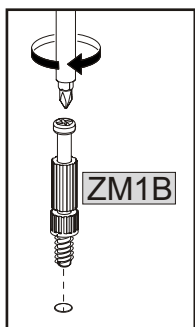
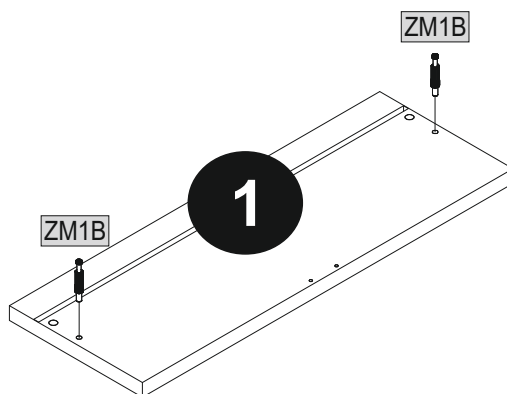

08

x2



Ø8x35

KT1

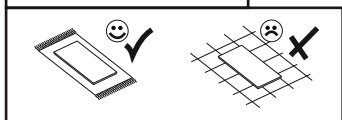
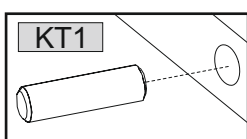
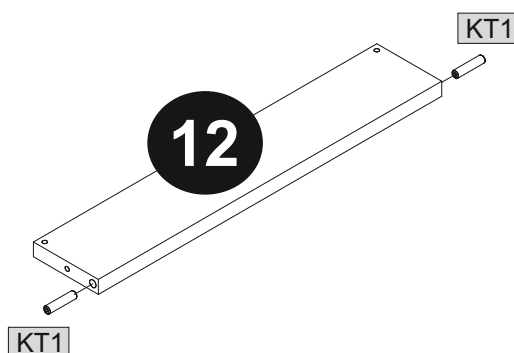

4



ROMA SZAFKA NOCNA

09

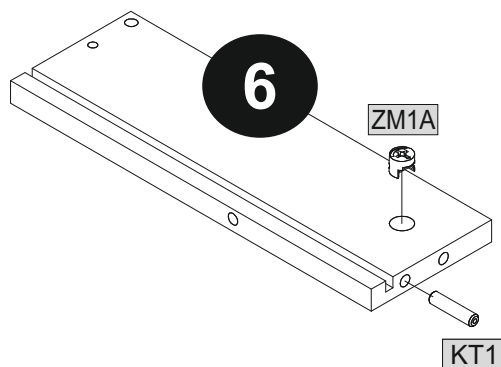
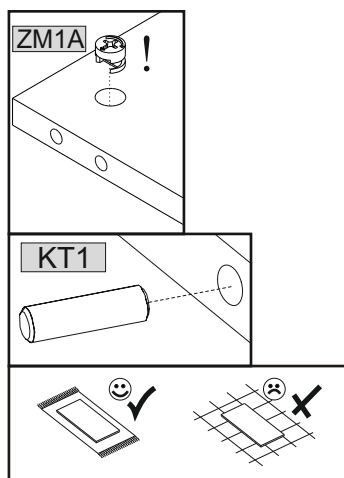

x2

	$\varnothing 8 \times 35$		15x15
KT1	2	ZM1A	2



10

x2

	$\varnothing 8 \times 35$		15x15
KT1	2	ZM1A	2

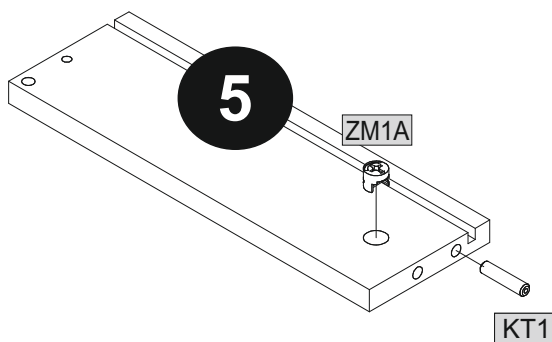
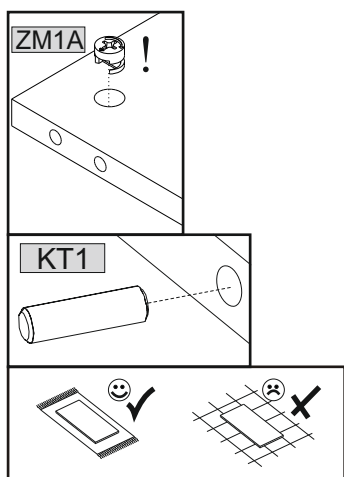

ROMA SZAFKA NOCNA

11

x2

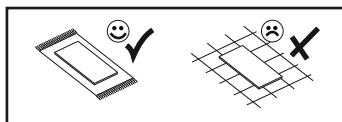
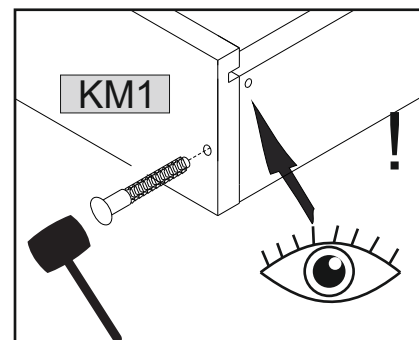
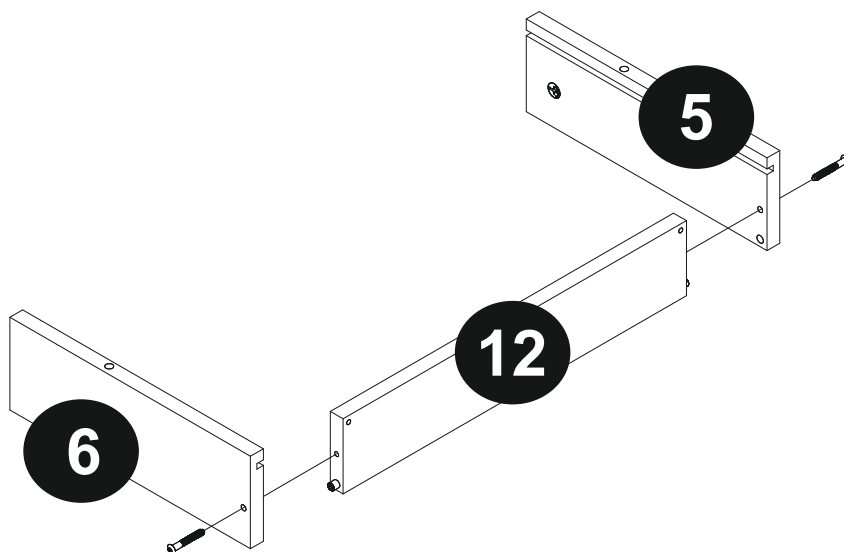
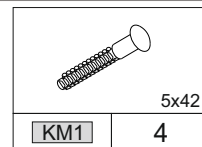

12

x2

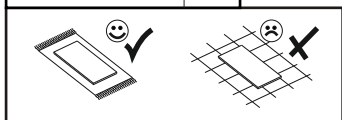
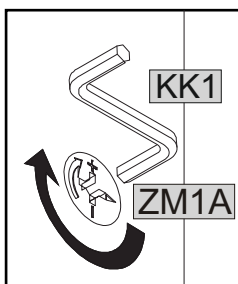
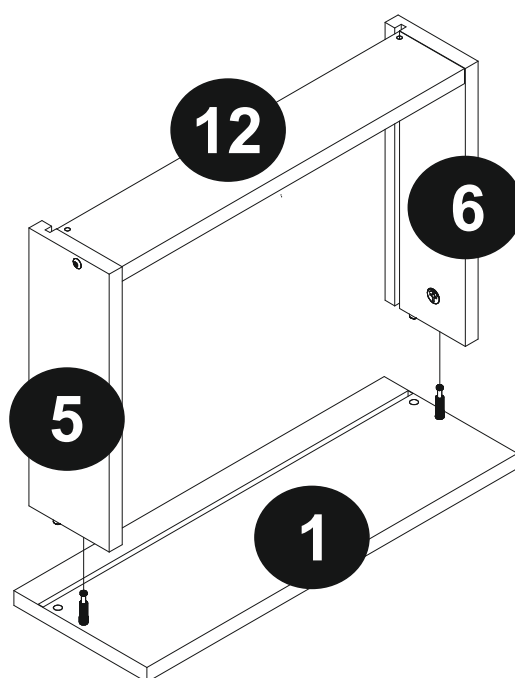
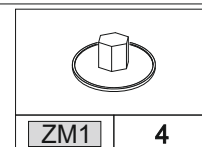

ROMA SZAFKA NOCNA

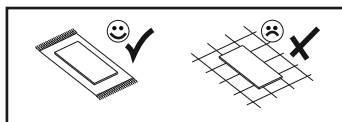
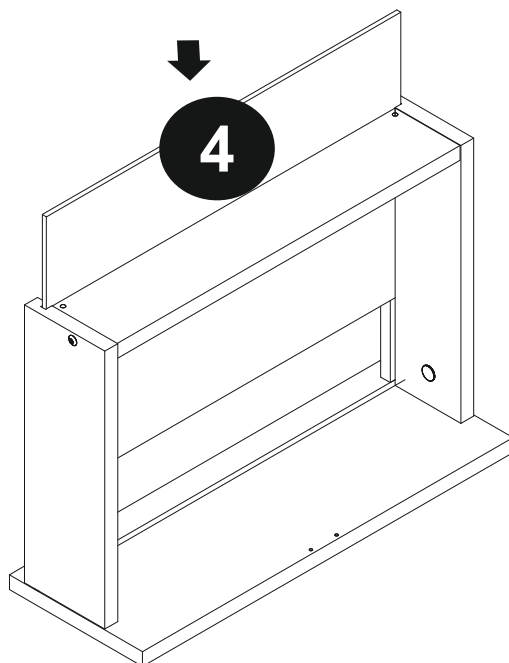

13

x2



14

x2

			3x16
S1	2	W1	8

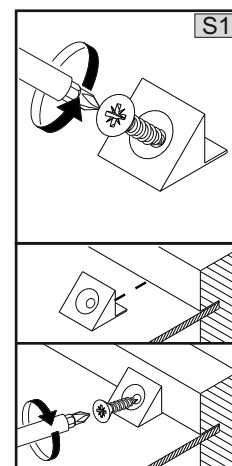
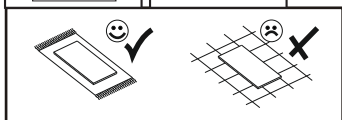
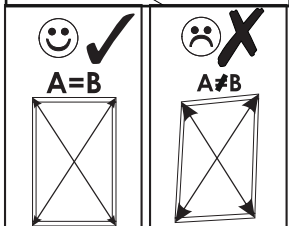
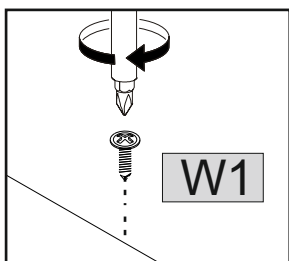
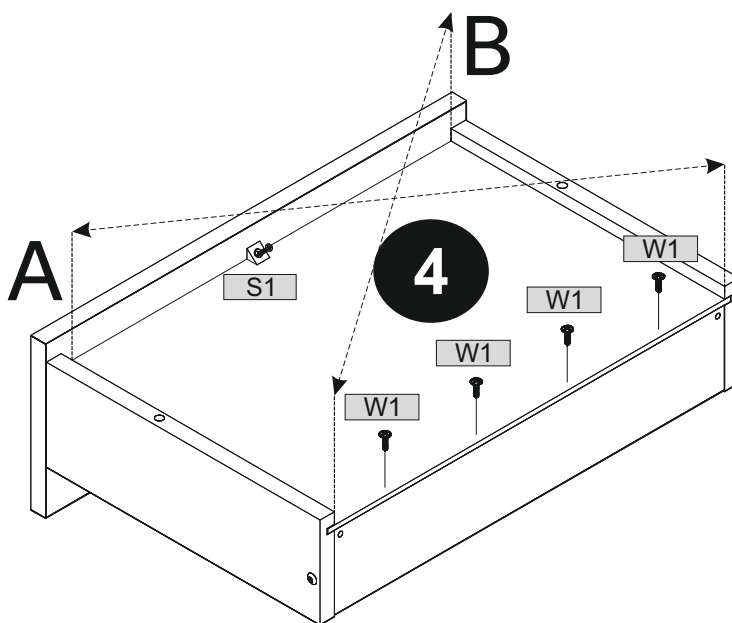

ROMA SZAFKA NOCNA

15

x2

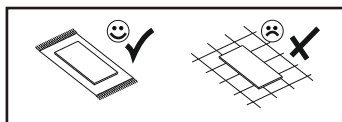
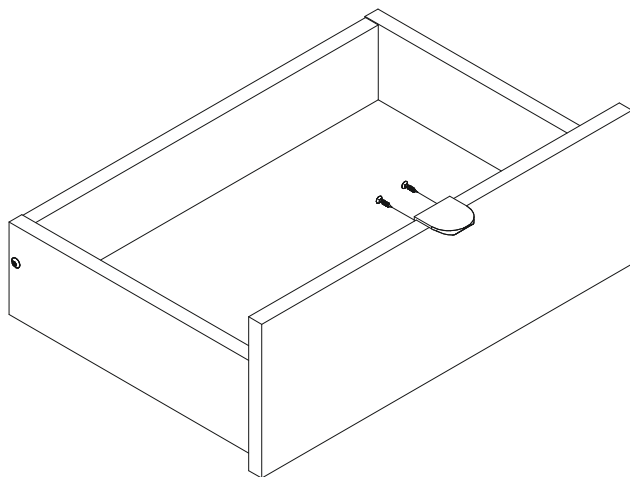
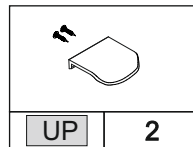

16

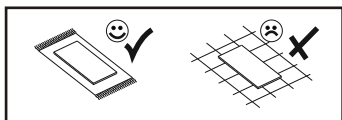
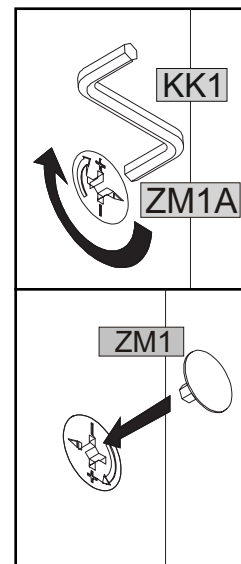
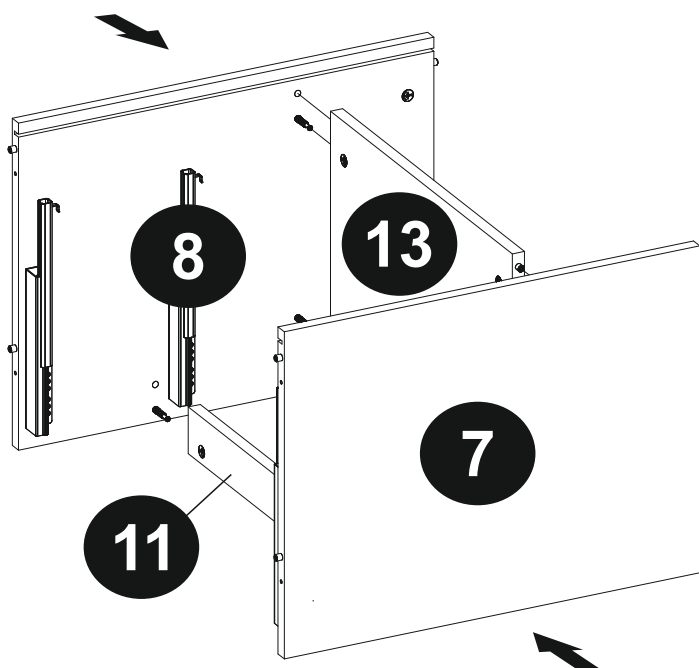
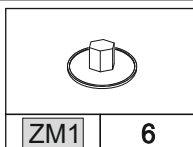

11/14

ROMA SZAFKA NOCNA

17

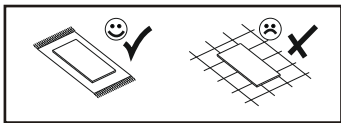
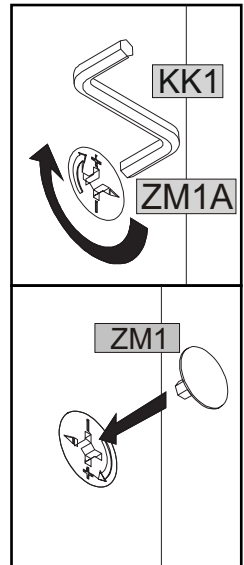
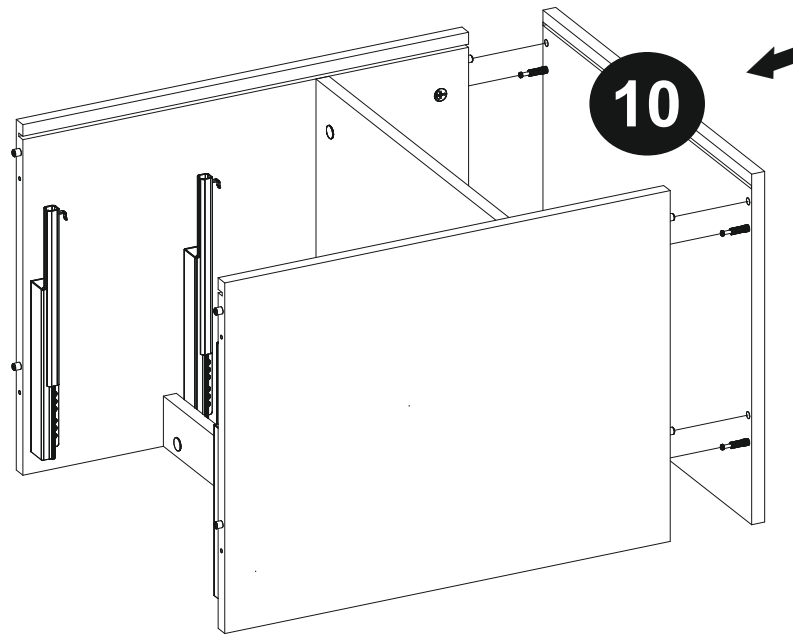
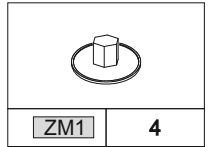

18

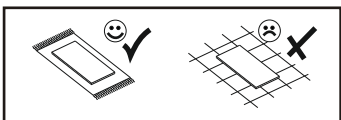
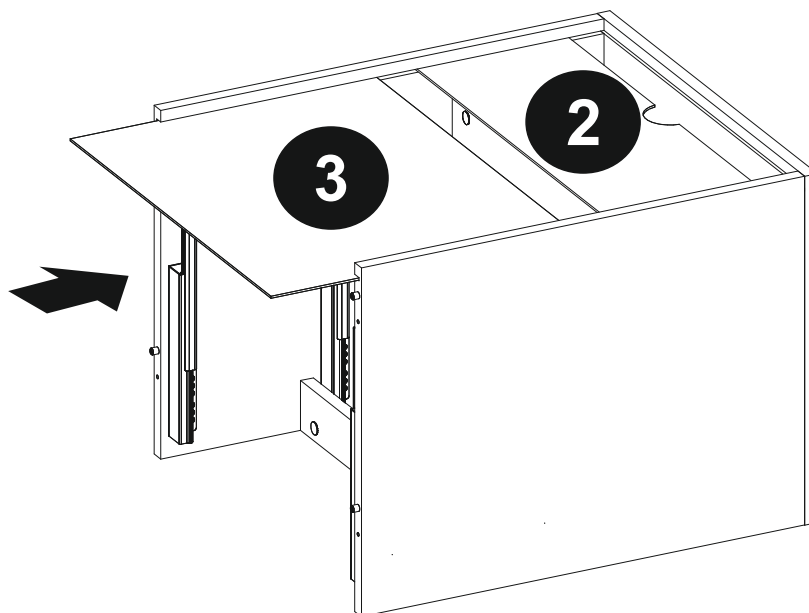



ROMA SZAFKA NOCNA

19

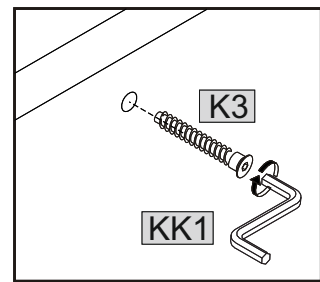
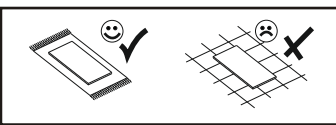
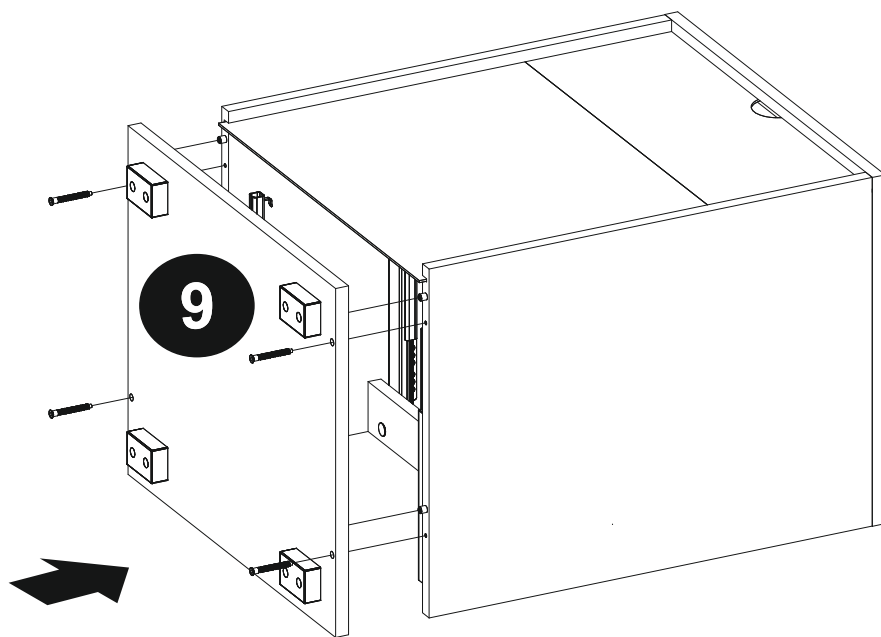
	
6,4x50	
K3	4



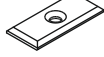

20

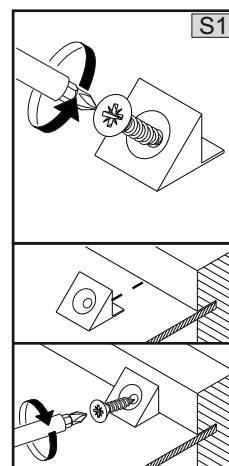
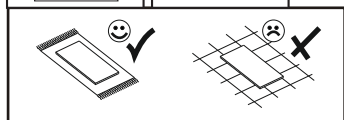
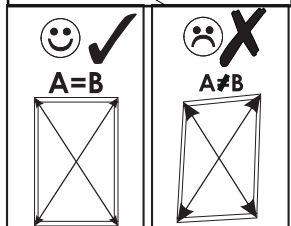
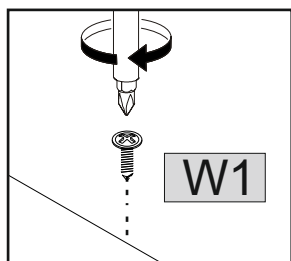
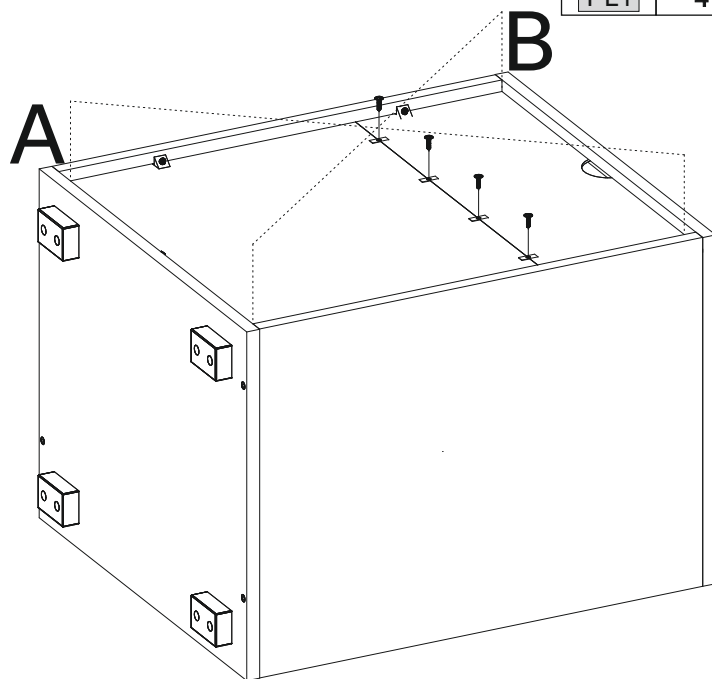
		
PL1	S1	W1
4	5	4

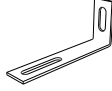
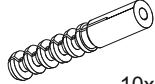

ROMA SZAFKA NOCNA

21

	3,5x16				10x50		6x50
W11	2	KS1	1	KRW1	1	KRL1	1

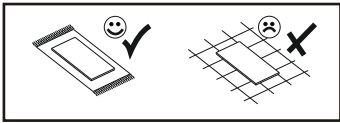
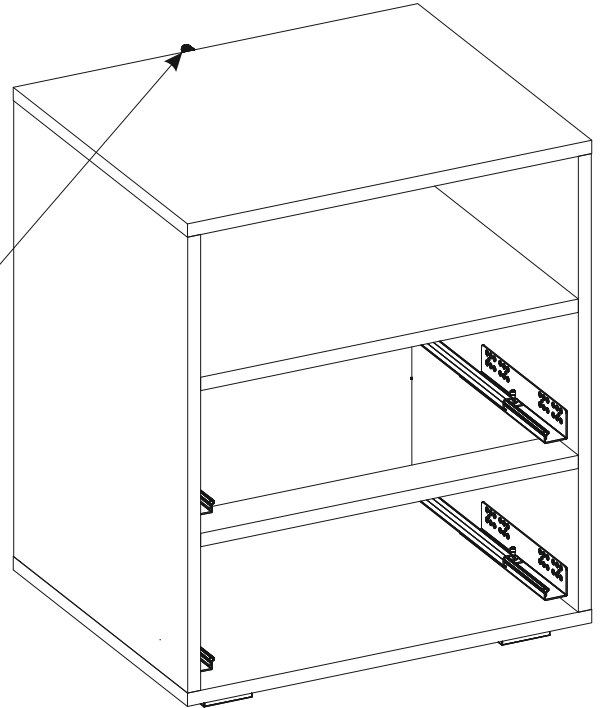
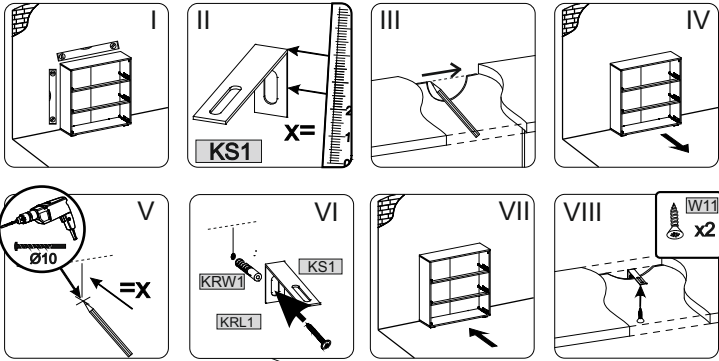

22

	3x16
W1	4

