

# ROMA STOLIK

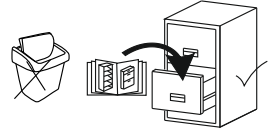

„MEBLE-OKMED” DEMKO - SPÓŁKA JAWNA  
ul. Kolejowa 13, 14-500 Braniewo, POLSKA  
[www.mebleokmed.pl](http://www.mebleokmed.pl) (+48) 55 243 27 26  
[firma@mebleokmed.pl](mailto:firma@mebleokmed.pl)

SERIA: .../...



ROMA STOLIK  
SERIA: ..../..

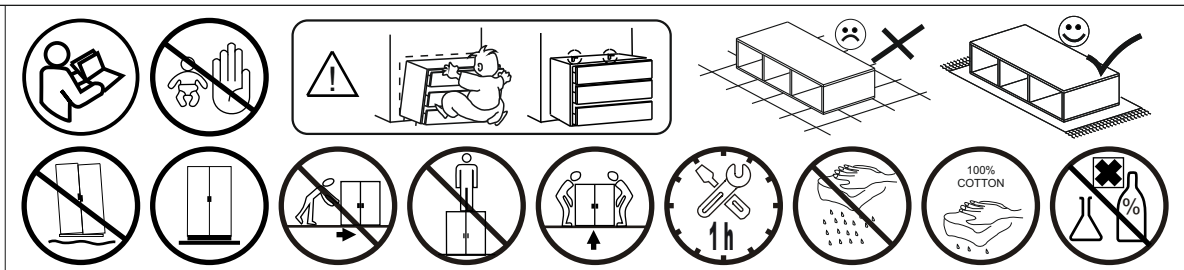
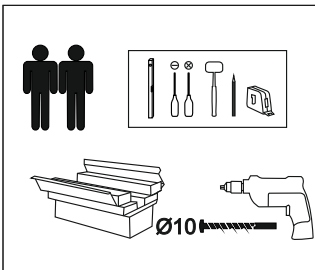
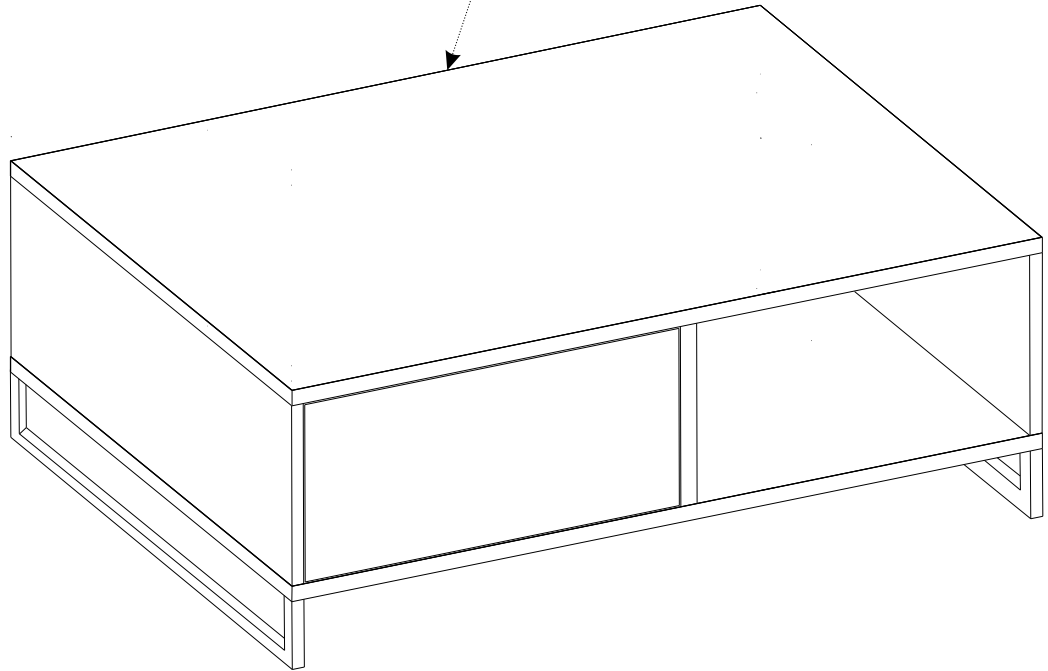



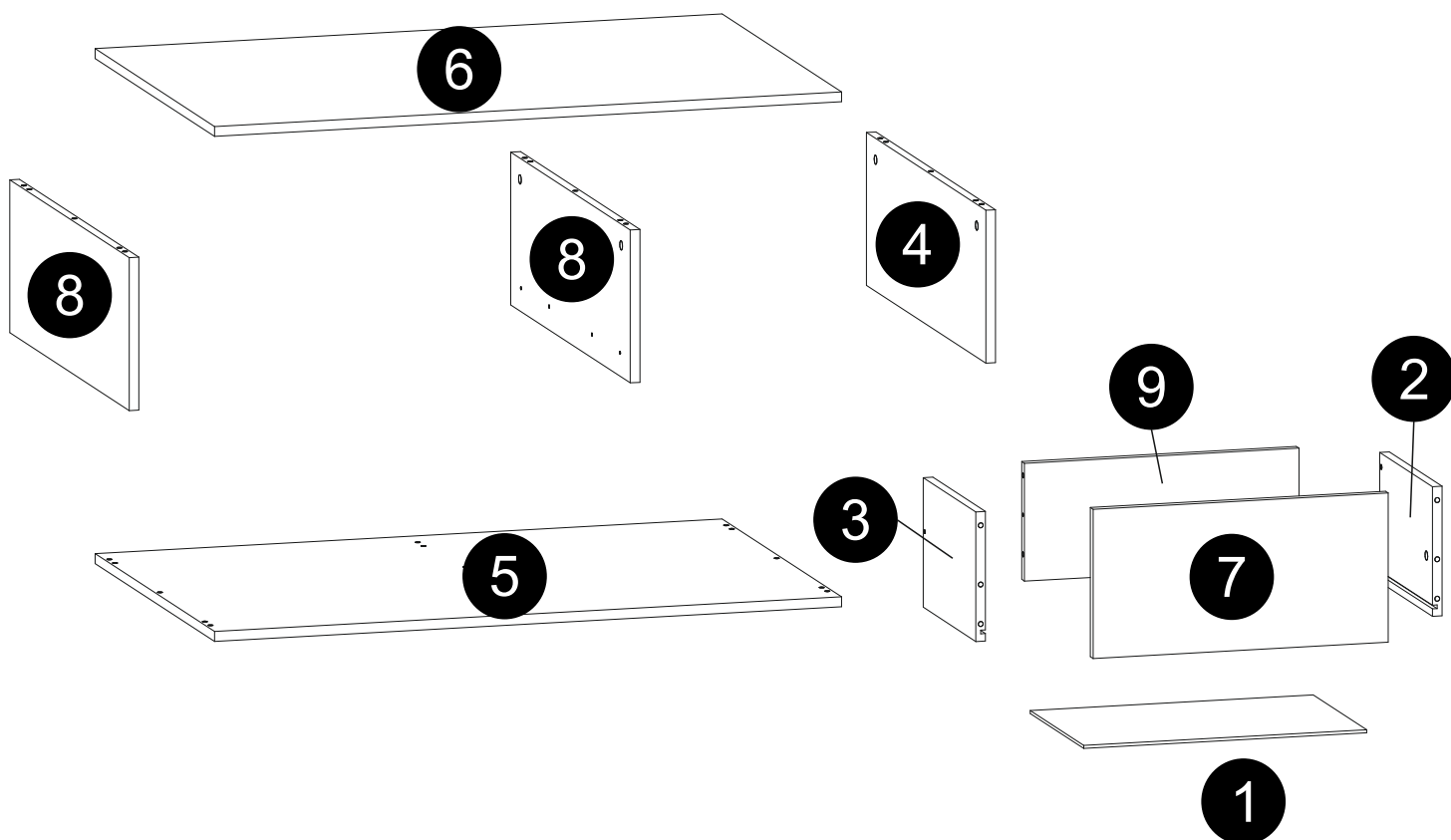

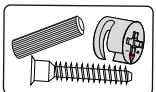



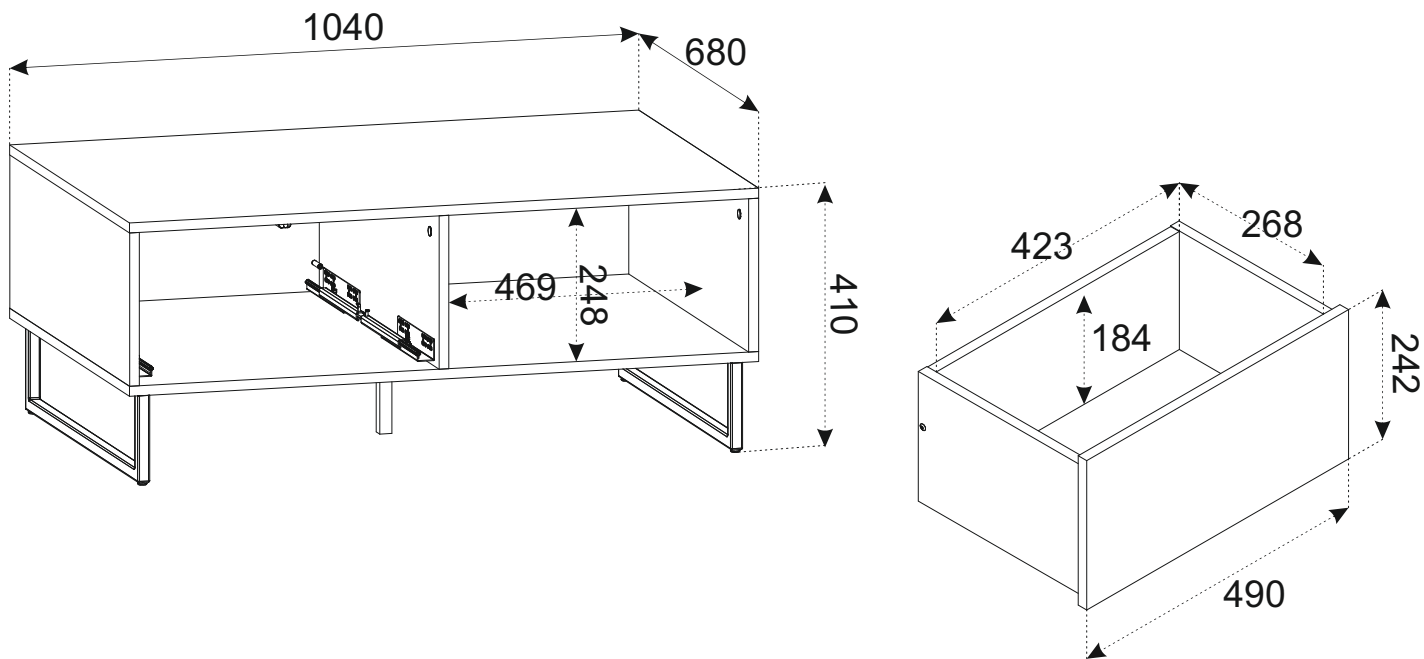



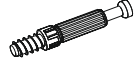

# ROMA STOLIK

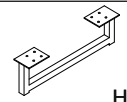

  <b>COLLI 1/1</b>					
N	L [mm]	W [mm]	T [mm]	Q	COLLI
1	468	305	5	2	1/1 COLL
2	300	210	16	2	1/1 COLL
3	300	210	16	2	1/1 COLL
4	680	248	16	1	1/1 COLL
5	1040	680	16	1	1/1 COLL
6	1040	680	16	1	1/1 COLL
7	242	490	16	2	1/1 COLL
8	680	248	16	2	1/1 COLL
9	456	191	16	2	1/1 COLL

# ROMA STOLIK

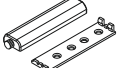
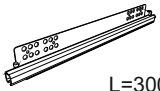
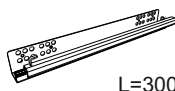

 4x16 W12   20	 3x16 W1   12	 3,5x16 W11   12	 15x15 ZM1A   10	 ZM1B   10	 6,3x13 ME3   8	 Ø8x35 KT1   34
 5x42 KM1   4	 6,4x50 K3   6	 ZM   10	 H150 NDB   2	 H150 NDB1   1	 S1   2	 OK1   2
 L=300 PQ3   2	 L=300 PQ4   2	 KK1   1				

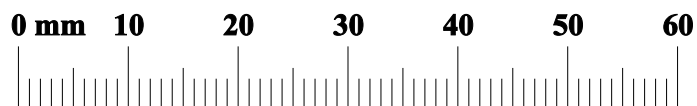

# ROMA STOLIK

**01**

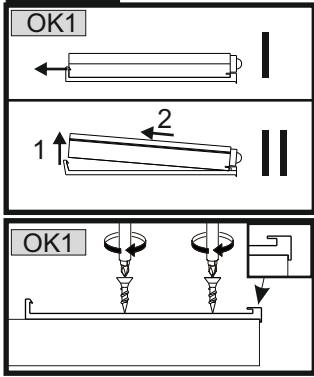

ZM1B	6	OK1	2

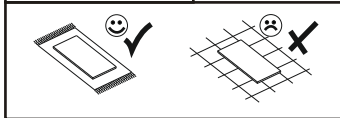
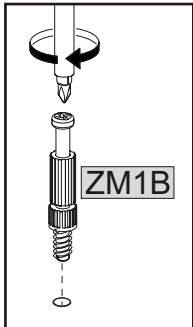
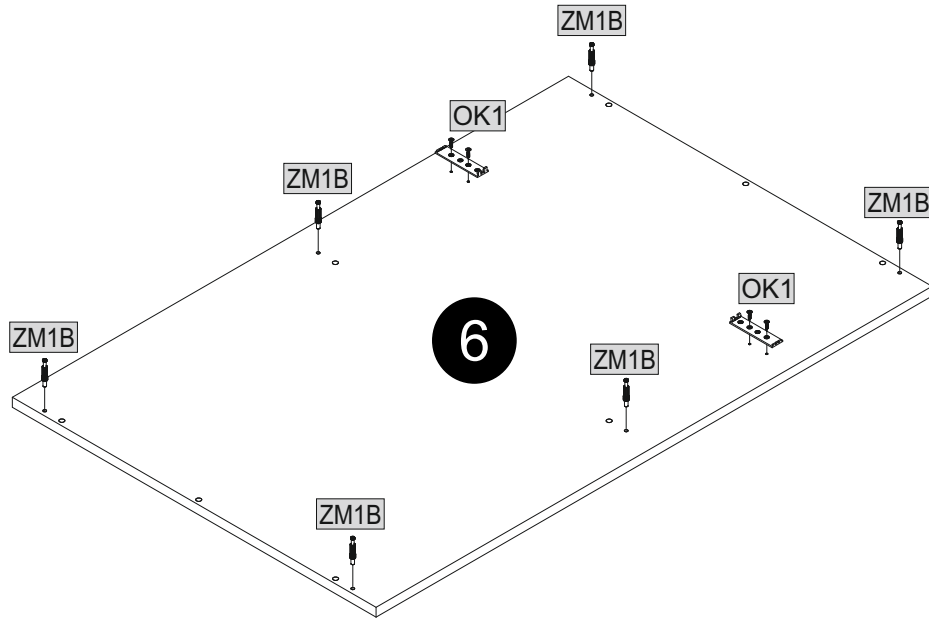

**02**

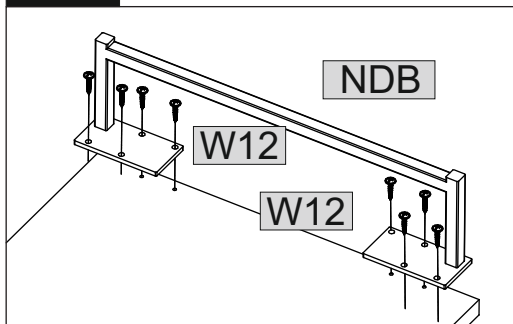



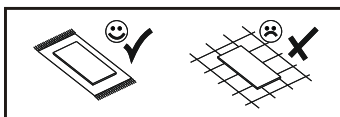
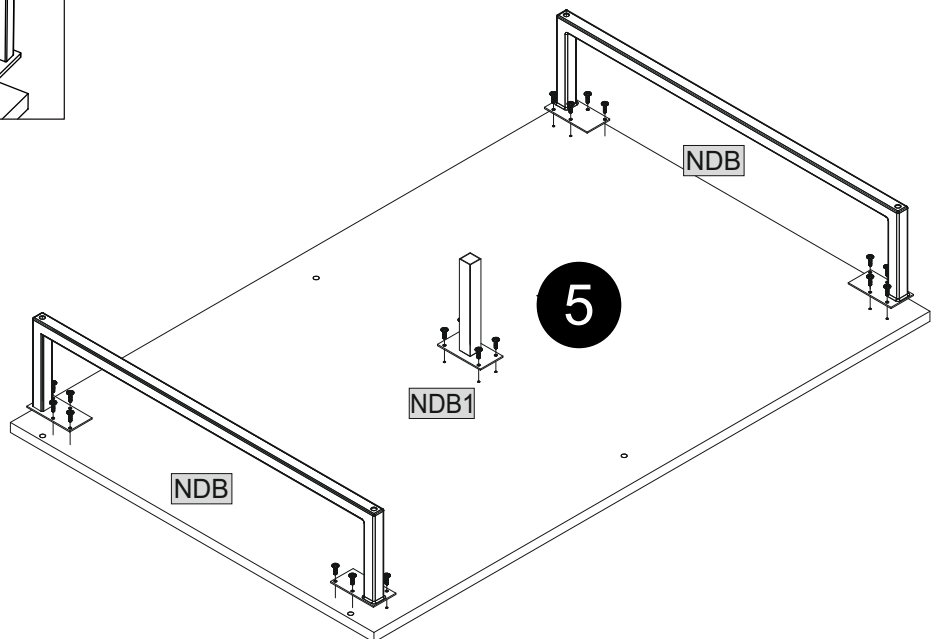
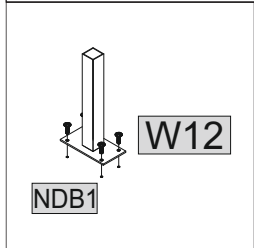

	4x16		H150		H150
W12	20	NDB	2	NDB1	1





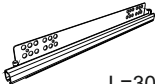
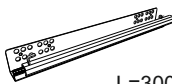

# ROMA STOLIK

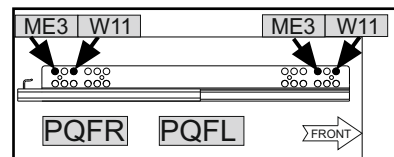
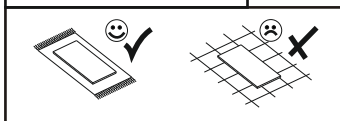
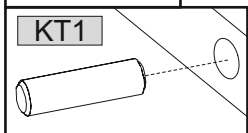
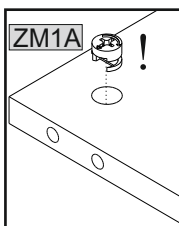
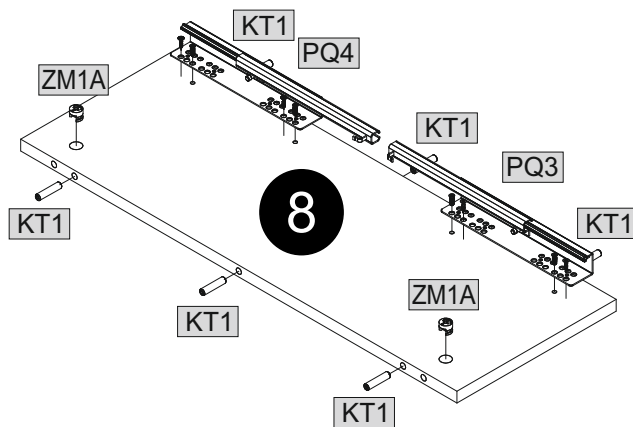
03

	3,5x16		6,3x13		15x15		Ø8x35		L=300		L=300
W11	4	ME3	4	ZM1A	2	KT1	6	PQ3	1	PQ4	1



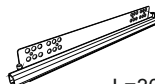
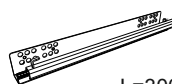

04

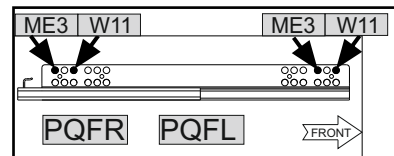
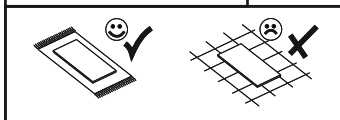
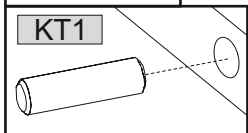
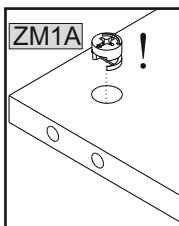
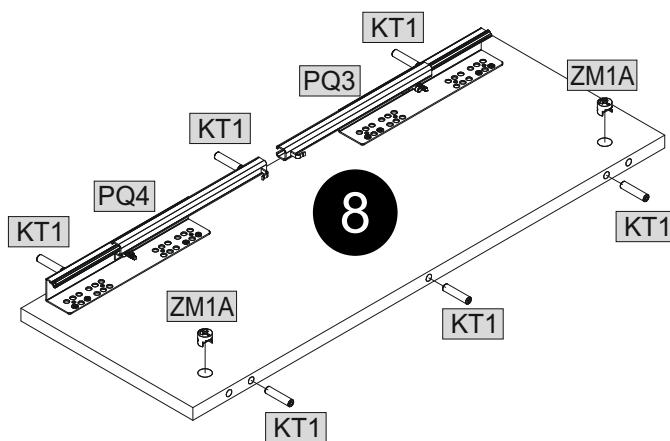
	3,5x16		6,3x13		15x15		Ø8x35		L=300		L=300
W11	4	ME3	4	ZM1A	2	KT1	6	PQ3	1	PQ4	1





# ROMA STOLIK

05

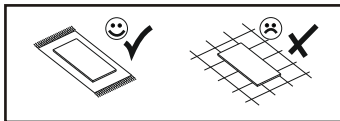
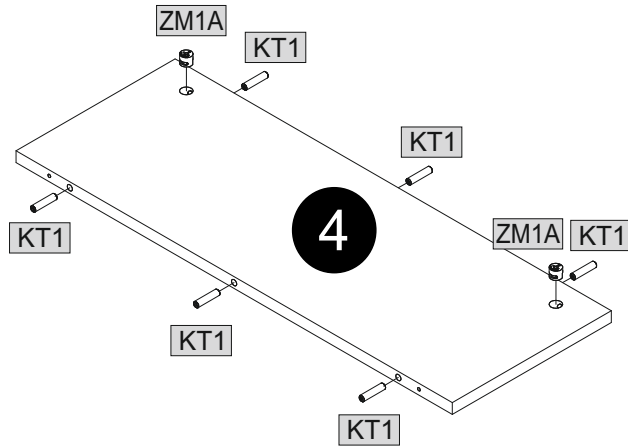
	15x15		Ø8x35
ZM1A	2	KT1	6



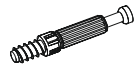

06

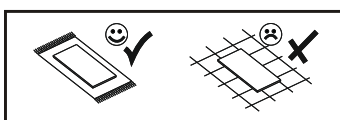
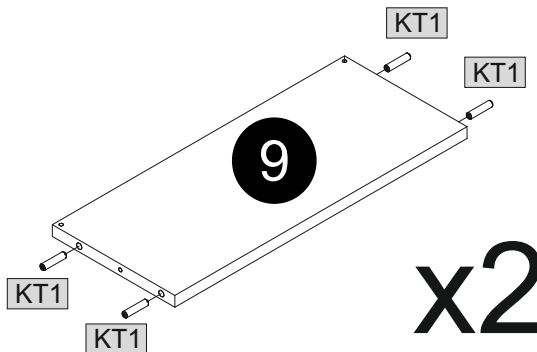
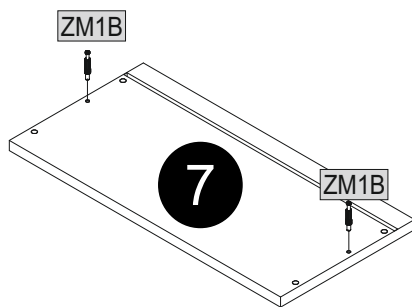
			Ø8x35
ZM1B	4	KT1	8



# ROMA STOLIK

07

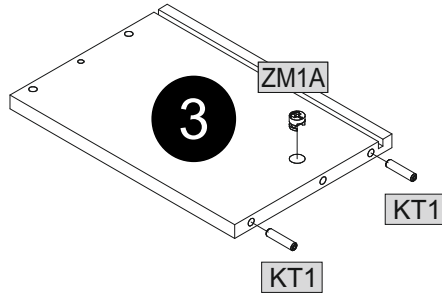

	15x15		Ø8x35
ZM1A	2	KT1	4

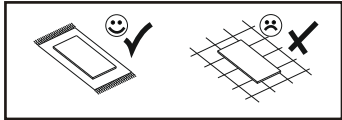

x2



08

	15x15		Ø8x35
ZM1A	2	KT1	4

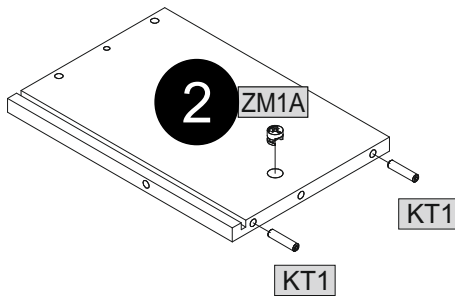

x2

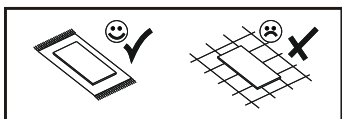

# ROMA STOLIK

09

	5x42
KM1	4

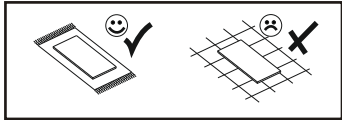
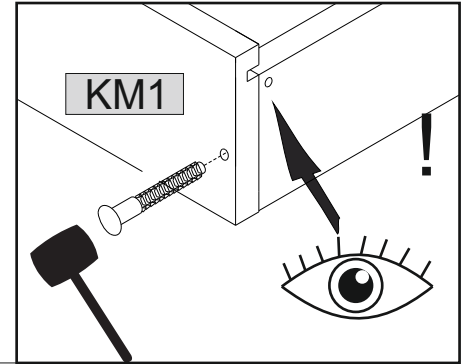
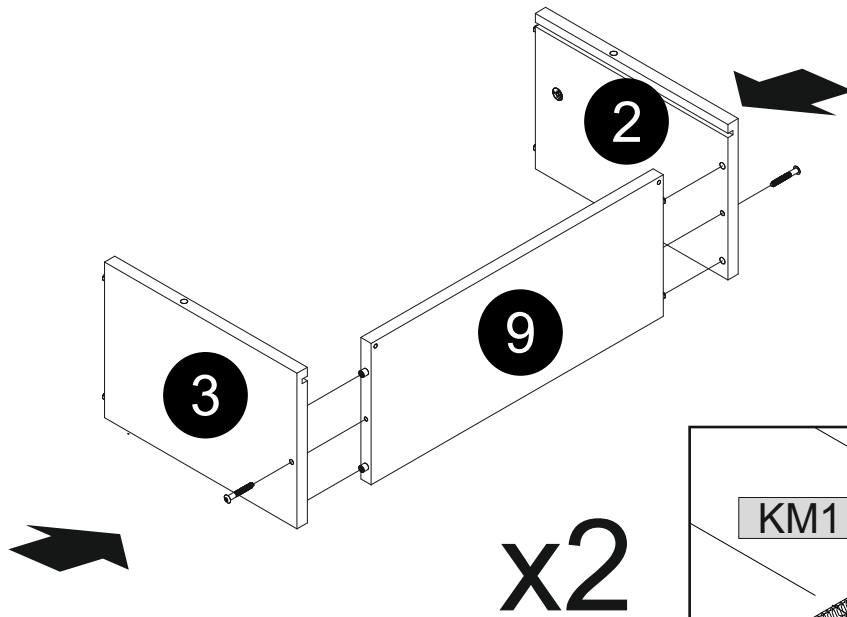

10

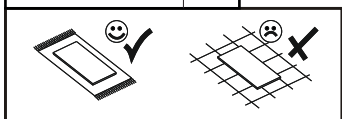
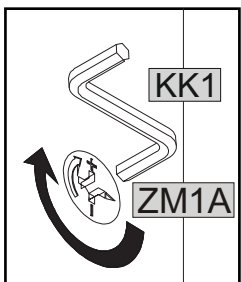
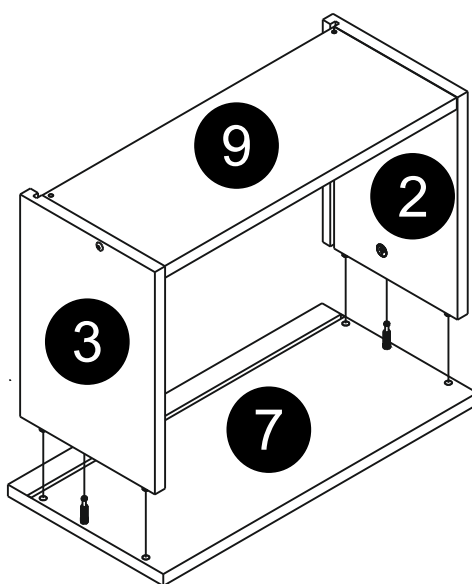

# ROMA STOLIK

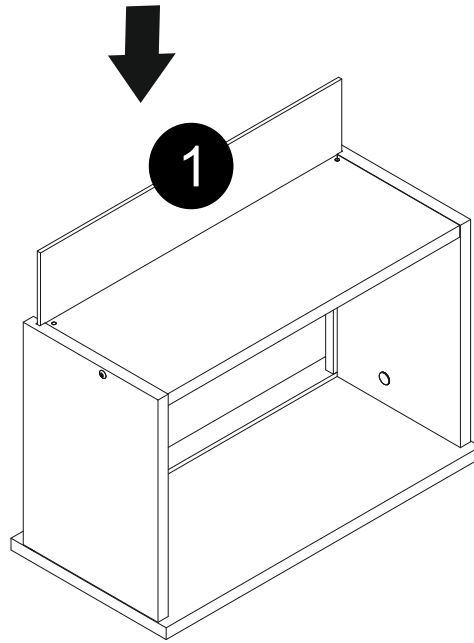

11

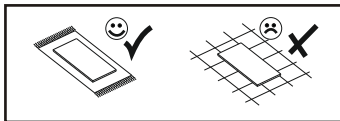

x2



12

			
3x16			
W1	8	S1	2

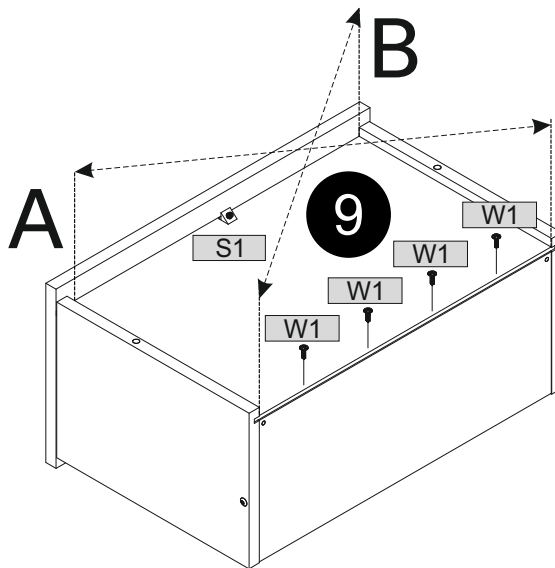

x2

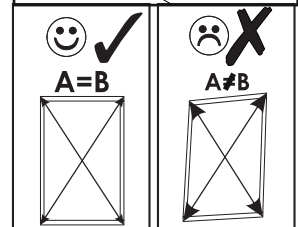
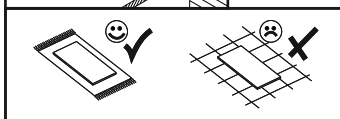
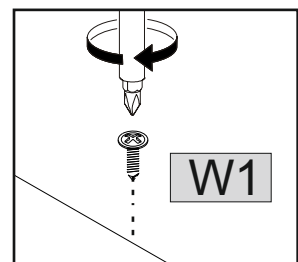
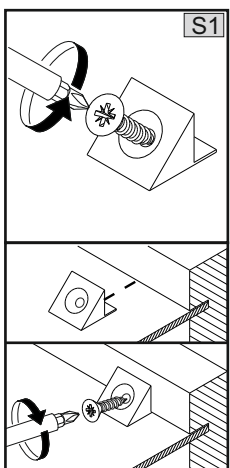

9/11

# ROMA STOLIK

13

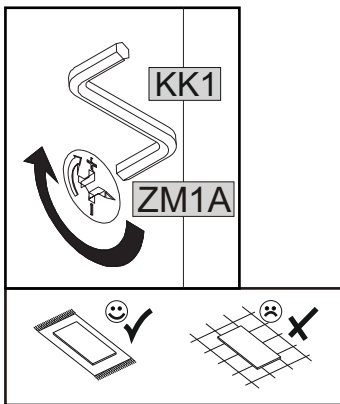
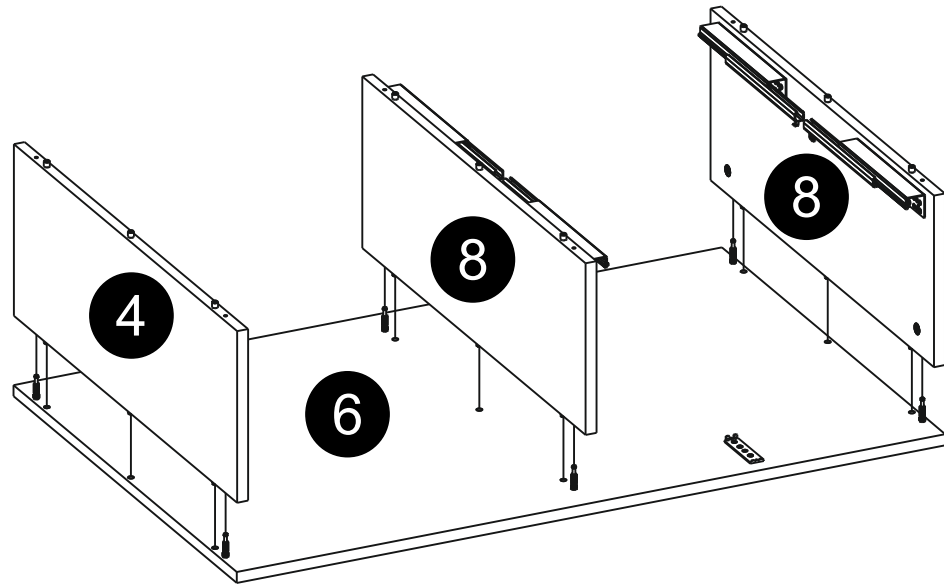

14

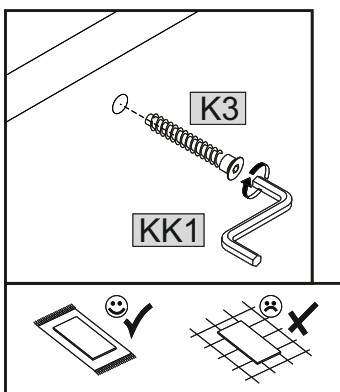
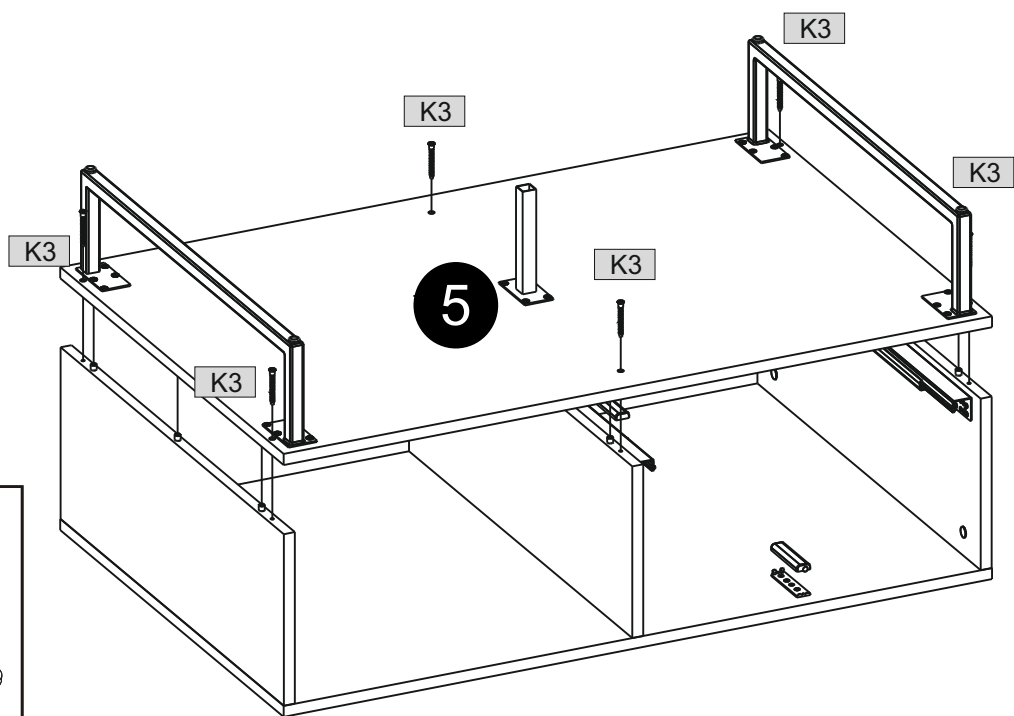
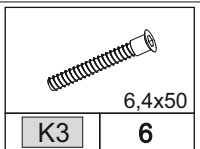

# ROMA STOLIK

15



3x16

W1

4

